



## Mass Flow Controller (MFC) for the dosing of liquids

- Dosing quantities up to 100 g
- Highest dosing accuracy
- High long-term stability, no zero-point adjustment necessary
- Highly resistant materials in contact with the medium
- Suitable for numerous liquids

Product variants described in the data sheet may differ from the product presentation and description.

### Can be combined with

	<b>Type ME63</b> Industrial Ethernet gateway, IP65/ IP67/ IP69k	▶
	<b>Type ME43</b> Fieldbus gateway	▶
	<b>Type 6013</b> Plunger valve 2/2 way direct-acting	▶
	<b>Type 6724</b> 2/2 or 3/2-way Whisper Valve with media separation	▶

### Type description

The mass flow controller (MFC) Type 8756 with integrated batch controller is especially suitable for dosing small quantities of liquids with the highest accuracy. The measuring principle of the sensor is based on the Coriolis effect and is completely independent of the medium. Pressure and temperature deviations have no influence on the dosing accuracy.

In addition to the flow rate, the density and temperature of the liquid are measured. The device design enables stable batch dosing that is robust against external influences and does not require zero adjustments when process conditions change. All wetted materials are highly resistant and allow use for a wide range of liquids, aggressive or not.

Type 8756 in the batch version is available in the following variants

- MFC with integrated solenoid valve Type 6013
- MFC with integrated solenoid valve Type 6724
- MFC with interface for a modular actuator.

The “Bürkert Communicator” software tool is available for easy parameterisation of the batch controller.

## Table of contents

<b>1. General Technical Data</b>	<b>3</b>
<b>2. Approvals</b>	<b>4</b>
<b>3. Materials</b>	<b>4</b>
3.1. Chemical Resistance Chart – Bürkert resistApp.....	4
<b>4. Dimensions</b>	<b>5</b>
4.1. MFC with valve Type 6724.....	5
4.2. MFC with valve Type 6013.....	6
4.3. MFC with modular actuator interface .....	7
<b>5. Device/Process connections</b>	<b>8</b>
5.1. CANopen or CANopen-based bus.....	8
<b>6. Performance specifications</b>	<b>9</b>
6.1. Dosing quantity depending on pressure and valve opening time < 100 g.....	9
6.2. Dosing quantity depending on pressure and valve opening time < 1 g.....	9
6.3. Reading sample .....	10
6.4. Reference setup.....	10
<b>7. Product operation</b>	<b>11</b>
7.1. Measuring principle .....	11
<b>8. Product accessories</b>	<b>11</b>
8.1. Software Bürkert Communicator .....	11
<b>9. Ordering information</b>	<b>12</b>
9.1. Bürkert eShop – Easy ordering and quick delivery.....	12
9.2. Recommendation regarding product selection .....	12
9.3. Bürkert product filter .....	12
9.4. Ordering chart.....	12
9.5. Ordering chart accessories.....	13

## 1. General Technical Data

Product properties	
Dimensions	Detailed information can be found in chapter "4. Dimensions" on page 5.
<b>Material<sup>1)</sup></b>	
Housing	Aluminium
Body (wetted)	Stainless steel 316L (optionally with inspection certificate 3.1 according to EN 10204)
Sensor (wetted)	Stainless steel 316L
Actuator (wetted)	Detailed information can be found in the section actuator.
Seals (wetted)	FFKM or PCTFE (Sealing materials of the valves can be found in the section actuator).
Configuration memory	Industrial µSIM card for easy device replacement
Total mass	> 2 kg
LED display <sup>2)</sup>	RGB-LED based on NAMUR NE107
Software	Bürkert Communicator (details see "8.1. Software Bürkert Communicator" on page 11)
Performance data	
Maximum flow rate	25 kg/h <sup>3)</sup>
Dosing precision	~ 0.4 % at 1 g under reference conditions (see "6.4. Reference setup" on page 10)
Minimum measurable flow rate	Factory setting: 0.08 kg/h (can be reduced to a minimum of 0.01 kg/h)
Maximum operating pressure	16 bar(g) (higher operating pressures on request)
Accuracy (flow)	± 0.2 % o.R. ± 0.0014 kg/h
Repeatability (flow)	± 0.1 % o.R. ± 0.0007 kg/h
Accuracy (temperature)	± 1.0 K (with flow > 1.5 kg/h)
Repeatability (temperature)	± 0.5 K (with flow > 1.5 kg/h)
Leak integrity to the outside	< 10 <sup>-6</sup> mbar * l/s He (depending on seal material)
Actuator	
<b>Valve Type 6724</b>	
Smallest dosing amount	250 mg
Maximum pressure	5 bar
Viscosity (dynamic)	Up to 40 mPas
Wetted parts	EPDM, PEEK
Protection class	IP40
<b>Valve Type 6013</b>	
Smallest dosing amount	250 mg
Maximum pressure	16 bar (higher pressure on request)
Viscosity (dynamic)	Up to 350 mPas (higher viscosity on request)
Wetted parts	EPDM, stainless steel 1.4305 / 303; 1.4113 / 434; 1.4310 / 301; 1.4303 / 305L
Protection class	IP65
<b>Further actuators</b>	
In the modular version, further actuators can be connected. The internal dosing algorithm is capable of dosing with different actuators.	
Electrical data	
Operating voltage	24 V DC
Voltage tolerance	± 10 %
Power consumption	< 14 W (as MFC with actuator Type 6724 / Type 6013)
Media data	
Operating medium	Any neutral and aggressive liquids (chemical resistance of wetted parts assumed)
Calibration medium	Water
Medium temperature	0 °C...50 °C (higher on request)
Viscosity (dynamic)	0.3...350 mPas (higher on request)
Process/Port connection & communication	
Process connection	G 1/8, NPT 1/8, VCR 1/8, VCR 1/4, compression fitting (1/8, 1/4, 4 mm, 6 mm)
<b>Electrical connection (options)</b>	
CANopen or CANopen-based bus	1x M12 plug, 5 pin
Industrial Ethernet	Planned, information on request
Environment and installation	
Ambient temperature	0...50 °C (deviating temperature ranges on request)
Installation position	Any

Recommended installation position    Horizontal upright / Horizontal overhead (for optimal onward transport of trapped gas bubbles in the medium)

- 1.) The formulations of the components in contact with the medium do not contain any silicone components.
- 2.) Exact description of the LED colours: see User Manual
- 3.) For highly viscous media this value may not be achieved.

## 2. Approvals

**Note:**

- Approvals and conformities listed below must be stated when making enquiries. This is the only way to ensure that the product complies with all prescribed properties.
- Not all available instrument versions can be supplied with the below approvals or conformities.

Approvals	Description
	<b>Planned:</b> UL 61010 – 1 (ELECTRICAL EQUIPMENT FOR MEASUREMENT, CONTROL, AND LABORATORY USE - Part 1: General Requirements)
	<b>Planned:</b> CAN/CSA-C22.2 No. 61010 – 1 (ELECTRICAL EQUIPMENT FOR MEASUREMENT, CONTROL, AND LABORATORY USE – Part 1: General Requirements)
	<b>Conformity of all wetted materials</b> USP Class VI chapter “87 in vitro” and “88 in vivo, Implantation”
<b>FDA</b>	<b>Conformity of all wetted materials</b> FDA – Code of Federal Regulations Title 21 Paragraph 177 (CFR 21 177.2600)
	<b>Conformity of all wetted materials</b> Regulation (EG) No. 1935/2004 about materials and articles intended to come into contact with foodstuffs
 	<b>Planned: Explosion protection</b> ATEX/ IECEx: Zone 2, Cat. 3 G/D

## 3. Materials

### 3.1. Chemical Resistance Chart – Bürkert resistApp

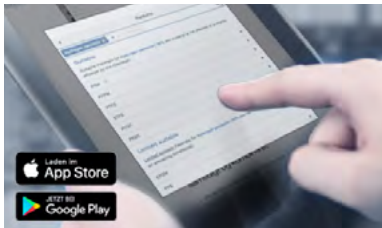

**Bürkert resistApp – Chemical Resistance Chart**

You want to ensure the reliability and durability of the materials in your individual application case? Verify your combination of media and materials on our website or in our resistApp.

Start Chemical Resistance Check

DTS 1000497674 EN Version: A Status: RL (released | freigegeben | valide) printed: 21.07.2021

## 4. Dimensions

### 4.1. MFC with valve Type 6724

**Note:**

- Dimensions in mm
- Shown connection: G $\frac{1}{8}$  (A)

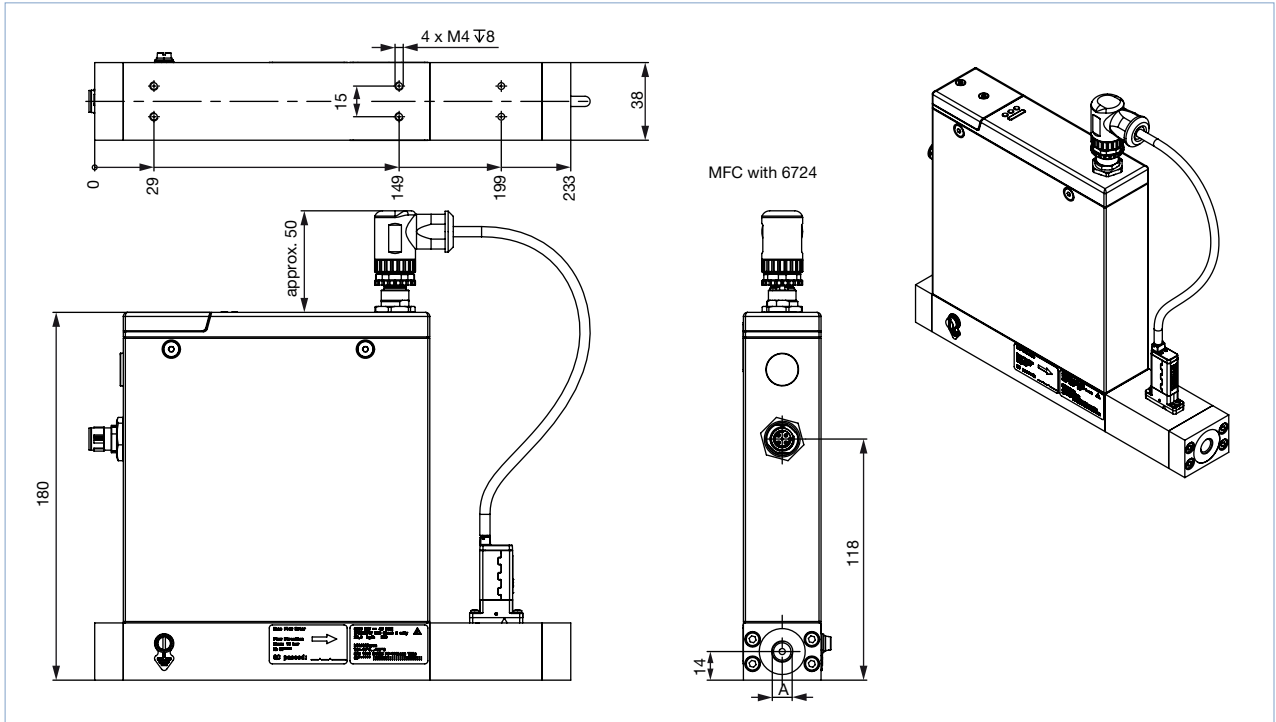

4.2. MFC with valve Type 6013

Note:

- Dimensions in mm
- Shown connection: G $\frac{1}{8}$  (A)

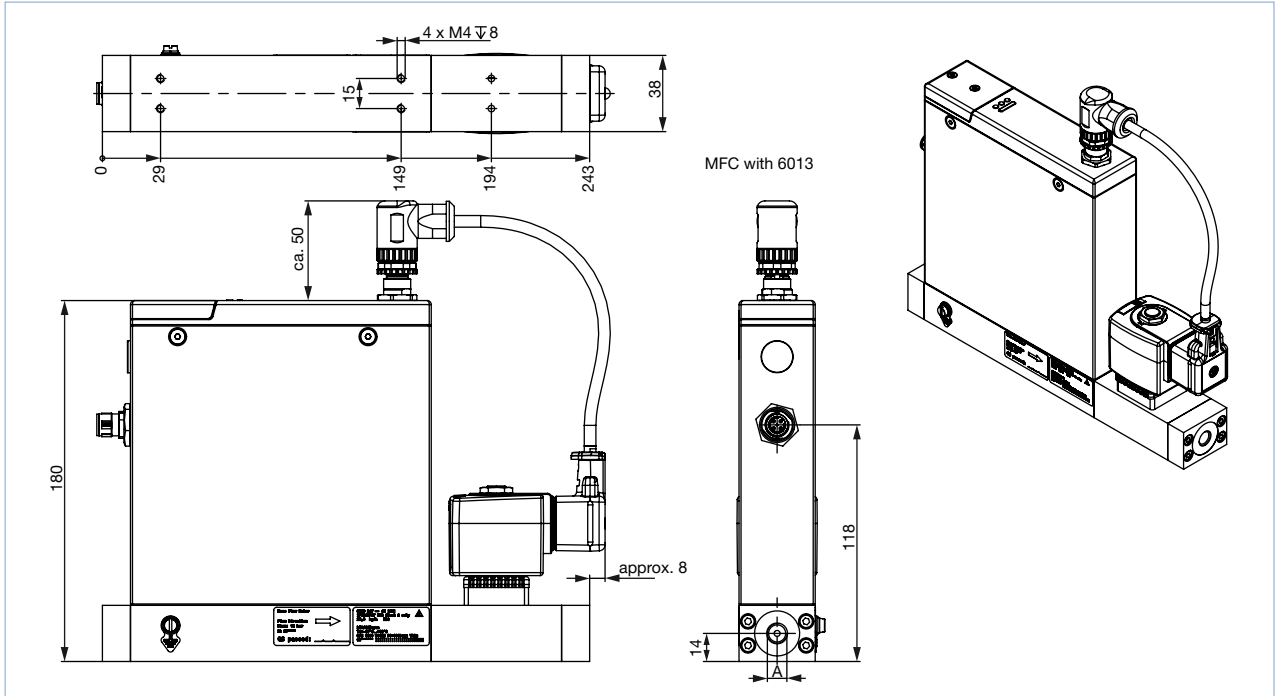

### 4.3. MFC with modular actuator interface

**Note:**

- Dimensions in mm
- Shown connection: G $\frac{1}{8}$  (A)

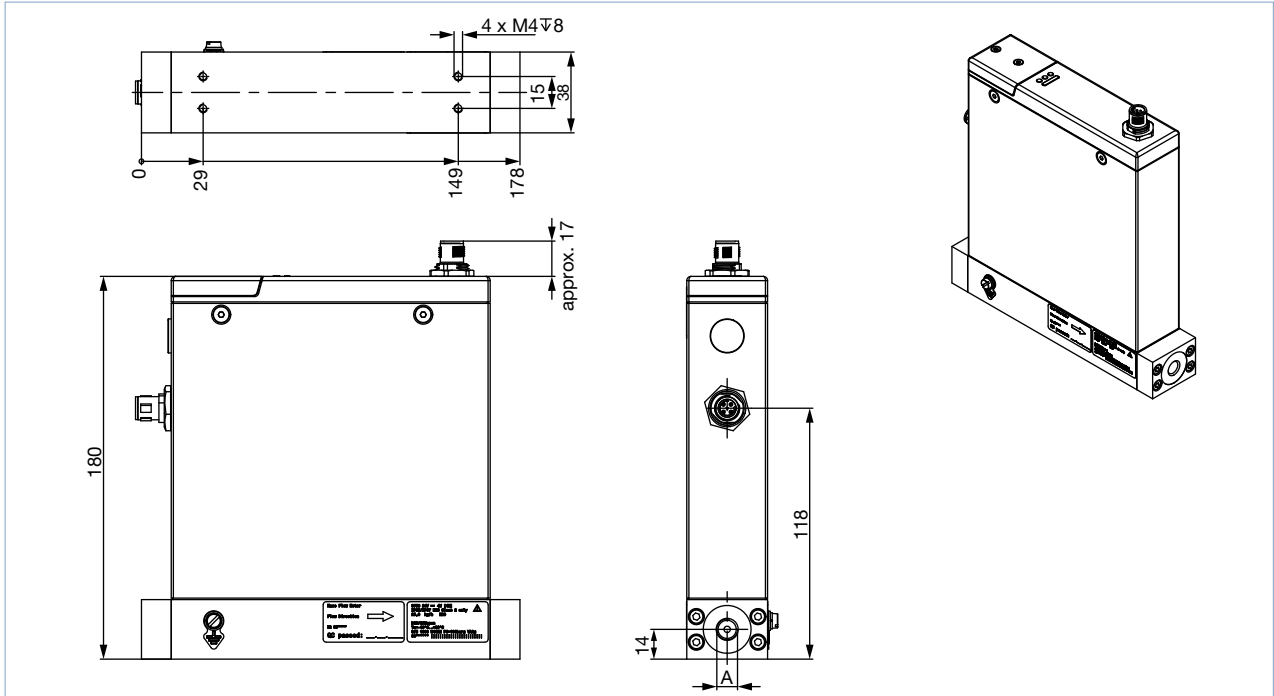

## 5. Device/Process connections

### 5.1. CANopen or CANopen-based büS

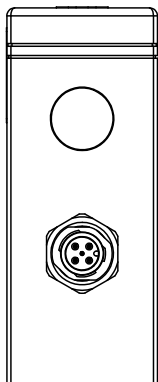

M12 plug, 5 pin (A-coded)		Pin	Assignment
	1	SHIELD	
	2	24 V	
	3	DGND	
	4	CAN_H	
	5	CAN_L	

For MFC with modular actuator interface additionally:

**Note:**

External actuators (e.g. solenoid valves) can be connected directly to Type 8756 Batch via the modular actuator interface. Thus, a closed control loop with sensor, actuator and integrated Batch controller can be realised in a modular way. Before initial commissioning, the Batch controller must be parameterised accordingly. The Bürkert Communicator with its simple commissioning script can be used for this purpose.

M12 socket, 8 pin (A-coded)		Pin	Assignment
	1	24 V	
	2	GND	
	6	PWM (open collector)	
	7	Do not connect (internal use)	
	3, 4, 5, 8	Not used	



## 6. Performance specifications

**Note:**

The following diagrams show the dosing range of the MFC. The dosing quantity can be freely selected from 0.2 g to 100 g. With different pressures and viscosities, the switch-on time of the actuator varies depending on the application.

### 6.1. Dosing quantity depending on pressure and valve opening time < 100 g

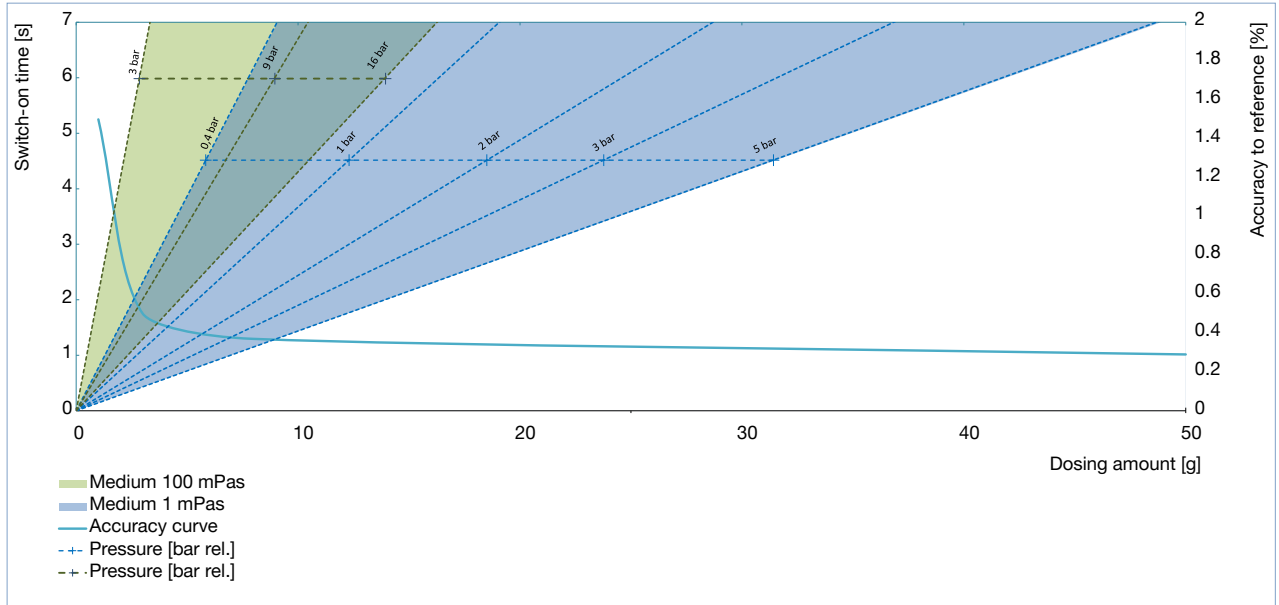

### 6.2. Dosing quantity depending on pressure and valve opening time < 1 g

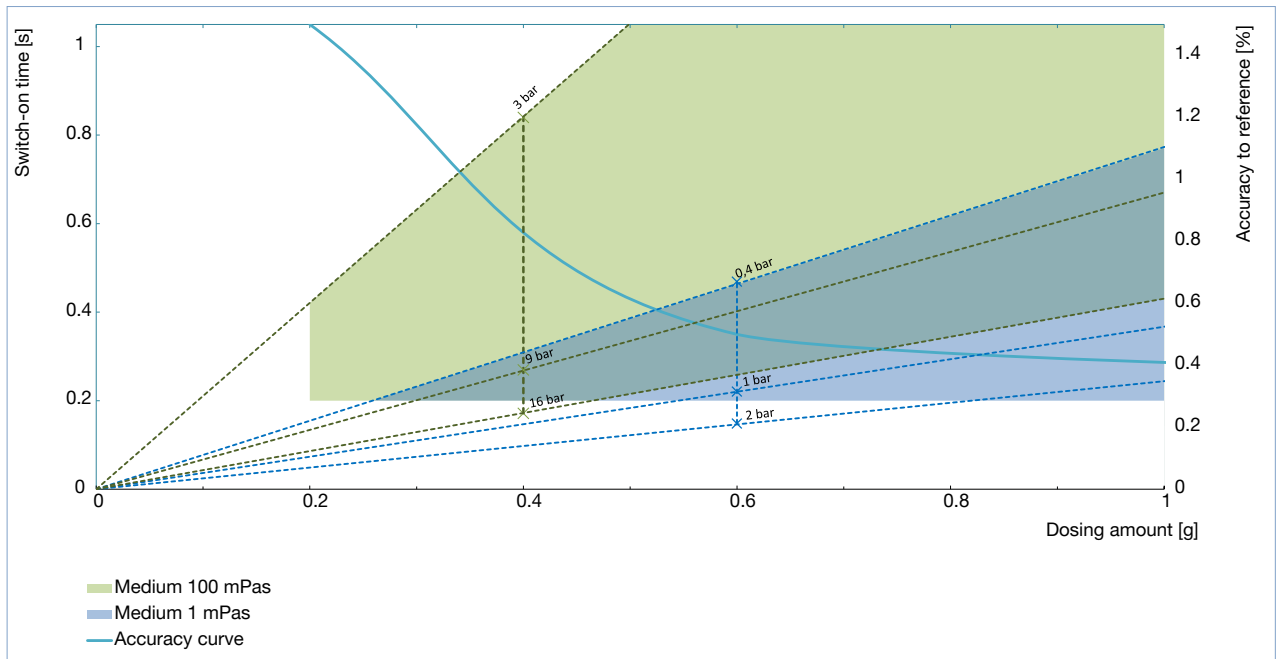

### 6.3. Reading sample

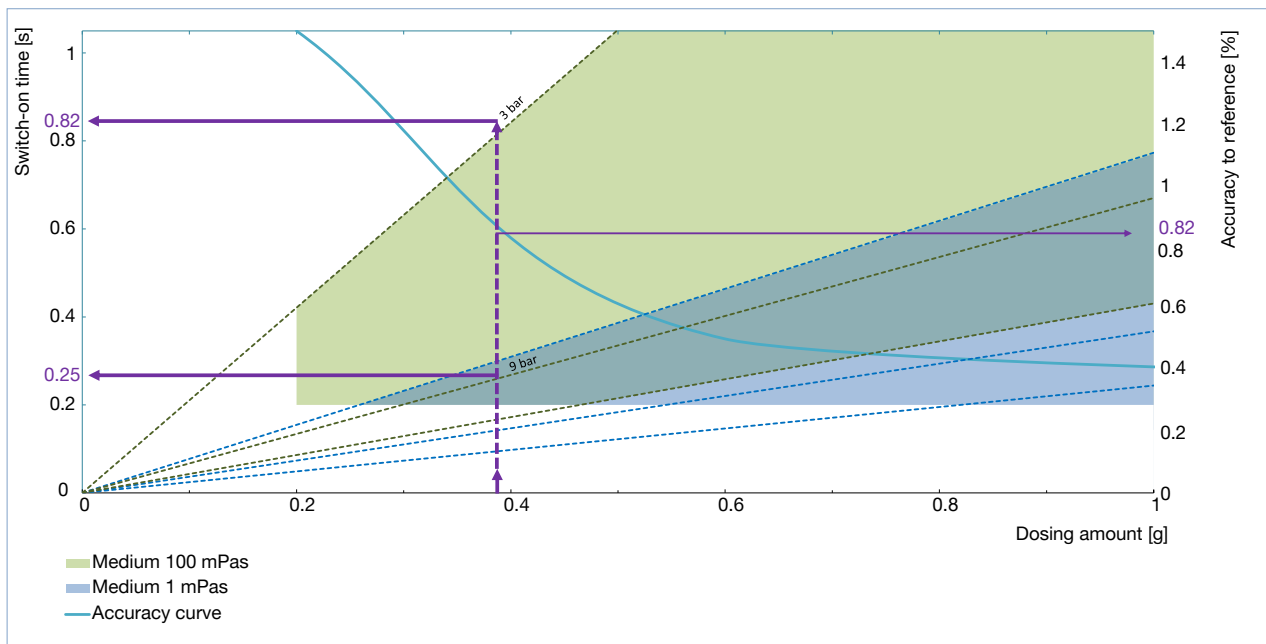

For example, you want to dispense 0.39 g in your application and are in the process of configuring your system. You can see from the diagram above that you would need a switch-on time of 0.82 s with an inlet pressure of 3 bar. If you had an inlet pressure of 9 bar in your system, this time would be reduced to 0.25 seconds. Depending on the application and requirements, different cycle times can be realised. The accuracy of the dosing quantity is 0.82 %, which is independent of the selected inlet pressure. The switch-on time of the actuator is the opening time of the valve that is required to dose the desired dosing quantity.

**Note:**

The diagram serves as an exemplary illustration of the dosing quantities that can be achieved. Reference set-ups were defined which correspond to the typical use of this unit.

### 6.4. Reference setup

The reference setup is a defined measurement setup under which the graphs in “6. Performance specifications” on page 9 were recorded. The pre-pressure of the medium was generated via an air cushion. A scale was used as a reference for checking the setpoint.

DTS 1000497674 EN Version: A Status: RL (released | freigegeben | valide) printed: 21.07.2021

## 7. Product operation

### 7.1. Measuring principle

The measuring principle of this flow sensor is based on the unique Coriolis effect.

The core of the measuring system is a thin S-shaped measuring tube, which is set in vibration by an external exciter coil and can vibrate freely between two fixed points. If a liquid flows through the high-frequency vibrating measuring tube, the Coriolis force acts on the medium and leads to a change in the tube vibration (see figure). This change (phase shift) is dependent on the mass flow of the medium and is directly proportional to it. With the help of sensors, the pipe vibrations are continuously recorded and electronically evaluated.

In addition to the flow rate, information on the density and temperature of the medium is also available as further values.

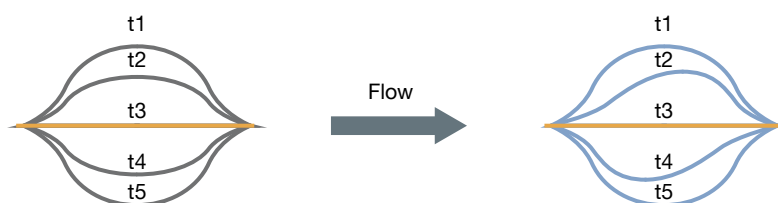

Pipe vibrations without medium

Pipe vibrations at fluid flow

t1...t5 deflections of the measuring tube at the respective point in time

## 8. Product accessories

### 8.1. Software Bürkert Communicator

#### Note:

To install the software, click [here](#) ►.

Part of Bürkert's new EDIP program (Efficient Device Integration Platform) is the Bürkert Communicator. This software can be run under MS-Windows and it is available on Bürkert's website for free. The Bürkert Communicator allows convenient system configuration and parametrisation of all connected field devices. An accessory part, the bÜS stick serves as the interface between computer and process instruments (see "9.5. Ordering chart accessories" on page 13). It transfers "USB data" to "CAN data". The Communicator allows:

- Diagnosis
- Parametrization (e.g. setting the min./max. flow rates or, in case of modular design, setting the valve control)
- Registration and storage of process data
- To watch graph of process
- To update firmware of the devices connected
- Guided commissioning scripts

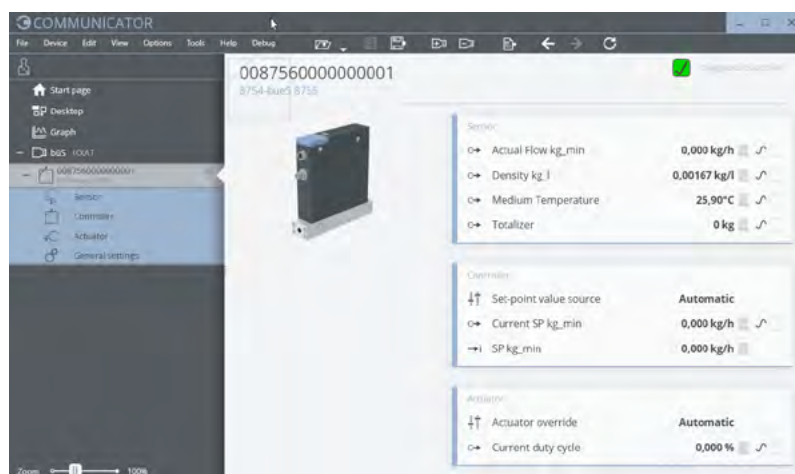

## 9. Ordering information

### 9.1. Bürkert eShop – Easy ordering and quick delivery



**Bürkert eShop – Easy ordering and fast delivery**

You want to find your desired Bürkert product or spare part quickly and order directly? Our online shop is available for you 24/7. Sign up and enjoy all the benefits.

[Order online now](#)

### 9.2. Recommendation regarding product selection

**Note:**

Please use the “**Product Inquiry Form**” at the end of this document for the device design details and send us a copy of the inquiry with information about the application.

For optimum design of the actuator in the MFC (nominal valve size), the pressure values immediately before and after the MFC ( $p_1$ ,  $p_2$ ) at the  $Q_{Nom}$  flow rate should be known in addition to the required maximum  $Q_{Nom}$  flow rate. These are generally not identical with the inlet and outlet pressure of the entire system, because there are usually additional flow resistances (pipelines, additional shut-off valves, nozzles, etc.) both upstream and downstream of the MFC.

In the “**Product Inquiry Form**” at the end of this document, the pressure values immediately before and after the MFC must always be indicated. If these are not known or accessible by measurement, an estimate must be made taking into account the approximate pressure drops across the flow resistances before and after the MFC at  $Q_{Nom}$ . The specification of the maximum expected inlet pressure  $p_{1max}$  is necessary to ensure the leak-tight function of the actuator in all operating conditions.

### 9.3. Bürkert product filter



**Bürkert product filter – Get quickly to the right product**

You want to select products comfortably based on your technical requirements? Use the Bürkert product filter and find suitable articles for your application quickly and easily.

[Try out our product filter](#)

### 9.4. Ordering chart

**Note:**



















Other versions on request

Version	Seal material	Port connection	Article no.
			büS/CANopen
Mass Flow Controller Batch with valve Type 6724	FFKM, EPDM	G 1/8 socket	20009219
Mass Flow Controller Batch with valve Type 6724	FFKM, EPDM	Swagelok VCR 1/4", male	572124
Mass Flow Controller Batch with valve Type 6724	FFKM, EPDM	VCR 1/8" male compatible to Swagelok	572125
Mass Flow Controller Batch with valve Type 6013	FFKM, EPDM	G 1/8 socket	572137
Mass Flow Controller Batch with valve Type 6013	FFKM, EPDM	Swagelok VCR 1/4", male	572138
Mass Flow Controller Batch with valve Type 6013	FFKM, EPDM	VCR 1/8" male compatible to Swagelok	572139
Mass Flow Controller Modular	FFKM	G 1/8 socket	572130
Mass Flow Controller Modular	FFKM	Swagelok VCR 1/4", male	572131
Mass Flow Controller Modular	FFKM	VCR 1/8" male compatible to Swagelok	572132

## 9.5. Ordering chart accessories

### Note:

- A büS-Stick is required to connect the MFC / MFM with the “Bürkert Communicator” software tool. It is connected via the micro USB socket on the device (büS-Stick set 2 contains the necessary accessories).
- Please note: The interface to our software tool “Bürkert Communicator” is based on CANopen. A corresponding bus termination is mandatory. Therefore please activate the switchable terminating resistor on the büS-Stick.

Description	Article no.
<b>General accessories</b>	
Power supply Type 1573 for rail mounting, 100...240 V AC / 24 V DC, 1.25 A, NEC Class 2 (UL 1310)	772438 
Power supply Type 1573 for rail mounting, 100...240 V AC / 24 V DC, 1 A, NEC Class 2 (UL 1310)	772361 
Power supply Type 1573 for rail mounting, 100...240 V AC / 24 V DC, 2 A, NEC Class 2 (UL 1310)	772362 
Power supply Type 1573 for rail mounting, 100...240 V AC / 24 V DC, 4 A	772363 
büS-Stick Set 1 (incl. cable (M12 and Micro-USB) Stick with integrated terminating resistor, power supply and software)	772426 
büS-Stick Set 2 (incl. cable (M12 and Micro-USB) Stick with integrated terminating resistor)	772551 
Configuration memory (Industrial µSim-Card)	On request
Software Bürkert Communicator	Download from <a href="http://www.burkert.com">www.burkert.com</a>
<b>CANopen/büS</b>	
büS cable extension M12 0.1 m	772492 
büS cable extension M12 0.2 m	772402 
büS cable extension M12 0.5 m	772403 
büS cable extension M12 1 m	772404 
büS cable extension M12 3 m	772405 
Connector M12, socket, straight (A-coded) <sup>1.)</sup>	772416 
Connector M12, plug, straight (A-coded) <sup>1.)</sup>	772417 
Connector M12, socket, angled (A-coded) <sup>1.)</sup>	772418 
Connector M12, plug, angled (A-coded) <sup>1.)</sup>	772419 
Y-junction	772420 
Y-junction for connecting two separately powered segments of a büS network	772421 
Termination resistor 120 Ohm M12 plug	772424 
Termination resistor 120 Ohm M12 socket	772425 
LabVIEW device driver	On request
EDS-File (CANopen)	Download from <a href="http://www.burkert.com">www.burkert.com</a>

1.) It is possible that the M12 connectors cannot be used together on the same side of a Y-junction. If that is the case, please use a prefabricated cable which uses typically a thinner connector.

# Bürkert – Close to You

For up-to-date addresses  
please visit us at  
[www.burkert.com](http://www.burkert.com)

DTS 1000497674 EN Version: A Status: RL (released | freigegeben | validé) printed: 21.07.2021



## Product Enquiry Form - Mass Flow Controller For Fluids

Thank you for your interest in our products! In order to provide you with optimum advice, please fill out the following form and send it to your **Bürkert representative** or e-mail address: [info@burkert.com](mailto:info@burkert.com). All information submitted will of course be kept strictly confidential.

Please fill in the **required fields!**  \*

\*Note: The interactive functions of this PDF may be restricted depending on the PDF reader used.

Personal Information			
Company		Contact person	
Customer no.		Department	
Street		Postcode / Town	
Telephone no.		Email	

Delivery			
MFC Application	MFM Application	Quantity	Required delivery date

Medium data			
Type of liquid or liquid mixture			
Dynamic viscosity	mPas		
Medium temperature	°C	/	°F
Ambient temperature	°C	/	°F

Fluidic data						
Flow range $Q_{Nom}$	Min.		Max.		unit	
Inlet pressure at $Q_{Nom}$	$p_1$	=	barg <sup>1.)</sup>			
Outlet pressure at $Q_{Nom}$	$p_2$	=	barg <sup>1.)</sup>			
Max. inlet pressure	$p_{1max}$	=	barg <sup>1.)</sup>			
Density	kg/l					
Port connection	<b>Compression fitting:</b>		¼"	⅛"	4 mm	6 mm
	<b>Vacuum fitting (VCR)</b>					
	<b>Thread:</b>		G (DIN ISO 228/1)		NPT (ANSI B1.2)	⅜" ¼"

1.) Please indicate all pressure values as overpressure to atmospheric pressure [barg] (g = relative pressure)

Material specifications			
Seals	FFKM	PCTFE	Stainless steel

Electrical data		
Control / Communication Note: Please choose <b>one</b> of the following options!	Normsignal	CANopen/büS
	0 ... 5 V	CANopen
	0 ... 10 V	büS
	0 ... 20 mA	
	4 ... 20 mA	

Approvals / Conformities
UL
USP Class VI conformity
FDA conformity
EG 1935/2004 conformity

**Additional Requirements / Comment**

--

DTS 1000497674 EN Version: A Status: RL (released | freigegeben | validé) printed: 21.07.2021