





Mass Flow Controller for Gases (MFC)

- Nominal flow ranges from 0.010 I_N/min to 80 I_N/min
- High accuracy and repeatability
- Very fast settling times
- Protection class IP65
- Optional: Fieldbus interface

Product variants described in the data sheet may differ from the product presentation and description.

Can be combined with

	Type 6013 Plunger valve 2/2 way direct-acting	▶
	Type 0330 Direct-acting 2/2 or 3/2 way pivoted armature valve	▶
	Type 6027 Direct-acting 2/2 way plunger valve	▶

Type description

The mass flow controller (MFC) Type 8712 is suited for regulating the mass flow of gases over a big flow range. The thermal MEMS sensor is located directly in the gas stream and therefore reaches very fast response times. A direct-acting proportional valve from Bürkert guarantees a high sensitivity. The integrated PI controller ensures outstanding control characteristics of the MFC. Type 8712 can optionally be calibrated for two different gases; the user can switch between these two gases. As electrical interfaces both, analog standard signals and fieldbuses are available. The mass flow controller type 8712 fits for various applications, like e.g. burner controls, heat treatment, material coatings, bio reactors, fuel cell technology or test benches. This MFC is especially designed for use in harsh environments due to the high protection class.

Table of contents

1. General Technical Data	3
2. Materials	4
2.1. Chemical Resistance Chart – Bürkert resistApp.....	4
3. Dimensions	4
3.1. Standard version.....	4
3.2. Sub-base version.....	5
3.3. Version with external valve.....	6
4. Device/Process connections	7
4.1. Analogue version/Fieldbus version.....	7
5. Product operation	8
5.1. Measuring principle	8
5.2. Flow characteristic.....	9
Nominal flow range of typical gases.....	9
6. Ordering information	9
6.1. Bürkert eShop – Easy ordering and quick delivery.....	9
6.2. Recommendation regarding product selection	9
6.3. Bürkert product filter.....	10
6.4. Ordering chart accessories.....	10
6.5. Adapter sketch.....	11

1. General Technical Data

Product properties	
Material	
Block	Stainless steel
Body	PC (Polycarbonate)
Seal	FKM, EPDM (others on request)
Dimensions	Detailed information can be found in chapter "3. Dimensions" on page 4.
Total weight	1200 g (valve internally)
LED display	Indication for power, limit (with analogue signals) / communication (with fieldbus) and error
Performance data	
Nominal flow range (Q_{Nom})	0.01 ml _N /min...80 l _N /min (N ₂) Detailed information can be found in chapter "5.2. Flow characteristic" on page 9.
Measuring range	1:50, higher measuring range on request
Max. operating pressure	10 bar (145 psi) (depending on the nominal valve size)
Measuring accuracy	±0.8 % o. R. ±0.3 % F. S. (after 1 min. warm-up time)
Repeatability	±0.1 % F. S.
Response time (t95 %)	<300 ms
Electrical data	
Operating voltage	24 V DC
Power consumption ¹⁾	3.5...14 W (depending on version)
Voltage tolerance	±10 %
Residual ripple	<2 %
Electrical connection	Socket M16, round, 8 pin and socket D-Sub HD15, 15 pin with PROFIBUS DP: Socket M12, 5 pin (for IP65) or D-Sub 9 pin with CANopen: Plug M12, 5 pin (for IP65) or D-Sub 9 pin
Medium data	
Operating medium	Neutral, non-contaminated gases, others on request
Calibration medium	Operating gas or air with conversion factor
Medium temperature	-10 °C...+70 °C (-10 °C...+60 °C for oxygen)
Process/Port connection & communication	
Port connection	NPT ¼, G ¼, or screw-in fitting
Fieldbus option	PROFIBUS-DP, CANopen (D-Sub HD15 covered with sealed plate with fieldbus)
Digital outputs	Two relay outputs 1. Limit (Q_{Nom} almost reached) 2. Error (i.e. sensor fault) Load capacity: max. 60 V, 1 A, 60 VA
Digital inputs	Three 1. Start Autotune 2. Not assigned, Switch between gases when cal. for two gases 3. Not assigned
Digital (communication) interface	RS232, Modbus RTU (via RS-Adapter), RS485, RS422 or USB (see "6.4. Ordering chart accessories" on page 10)
Analogue interfaces	4...20 mA, 0...20 mA, 0...10 V or 0...5 V Input impedance >20 kΩ (Voltage) resp. <300 Ω (Current) Max. load: 10 mA (Voltage output); max. load: 600 Ω (Current output)
Environment and installation	
Installation position	Horizontal or vertical
Ambient temperature	-10 °C...+50 °C
Degree of protection	IP65
Accessories	
Software-Tool	Mass Flow Communicator

1.) The nominal flow value is the max. flow value calibrated which can be measured.

The nominal flow range defines the range of nominal flow rates (full scale values) possible.

2.) Index N: Flow rates referred to 1.013 bar and 0 °C. Alternatively there is an

Index S available which refers to 1.013 bar and 20 °C.

2. Materials

2.1. Chemical Resistance Chart – Bürkert resistApp

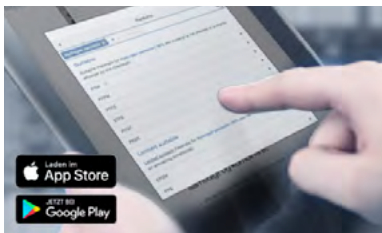

Bürkert resistApp – Chemical Resistance Chart

You want to ensure the reliability and durability of the materials in your individual application case? Verify your combination of media and materials on our website or in our resistApp.

[Start Chemical Resistance Check](#)

3. Dimensions

3.1. Standard version

Note:
Dimensions in mm

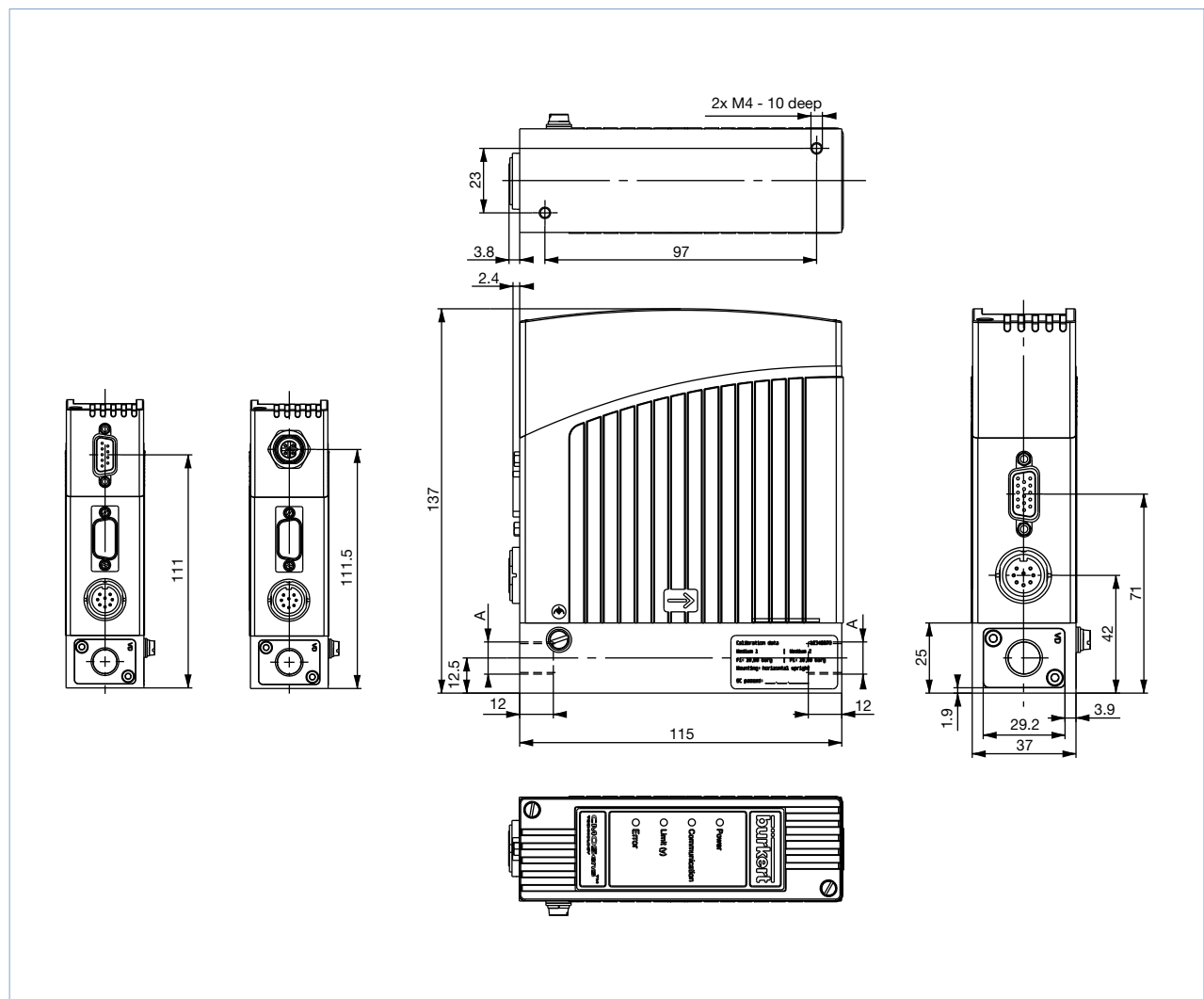

DTS 1000011287 EN Version: R Status: RL (released | freigegeben | valide) printed: 25.06.2021

3.2. Sub-base version

Note:

Dimensions in mm

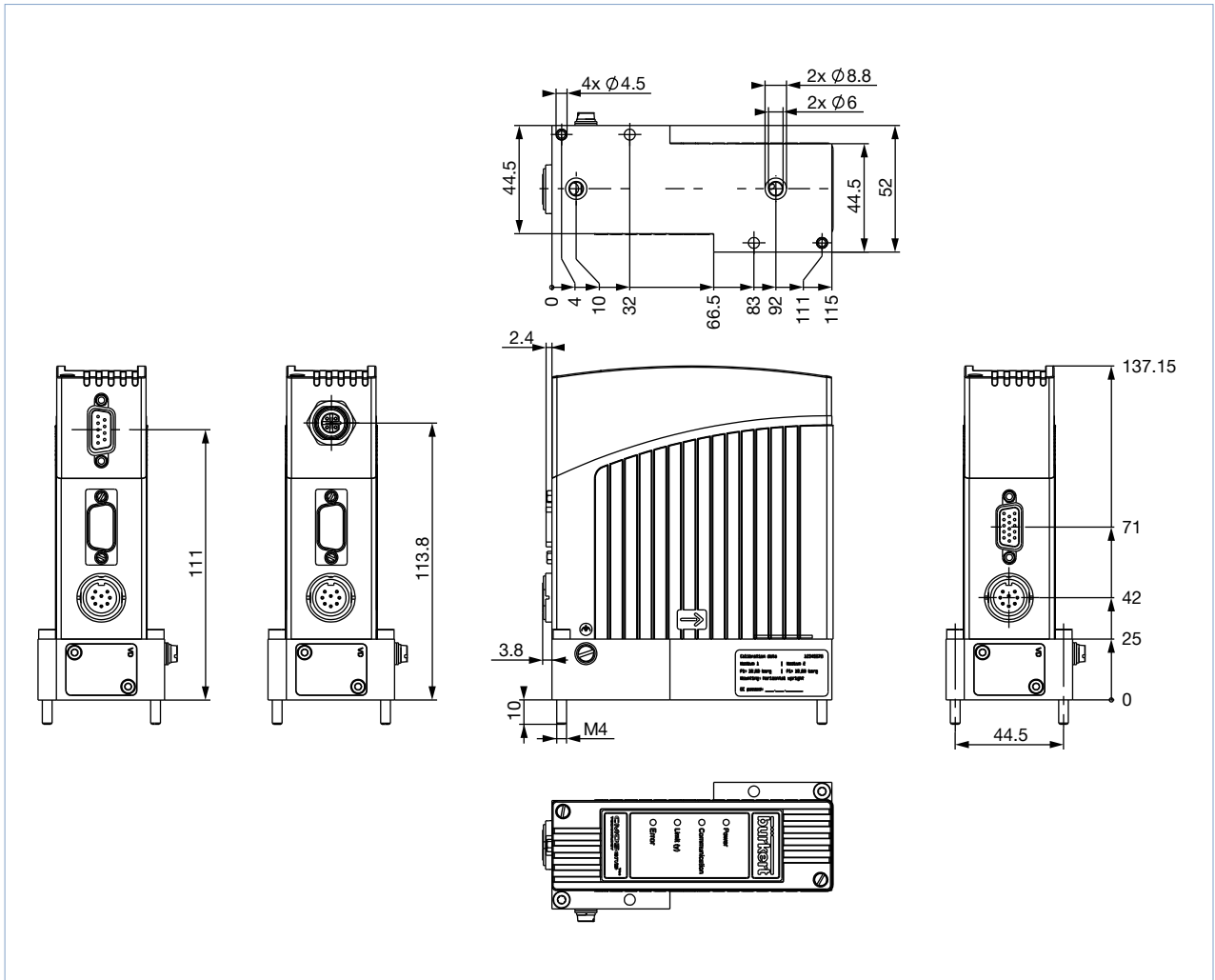

3.3. Version with external valve

Note:

Dimensions in mm

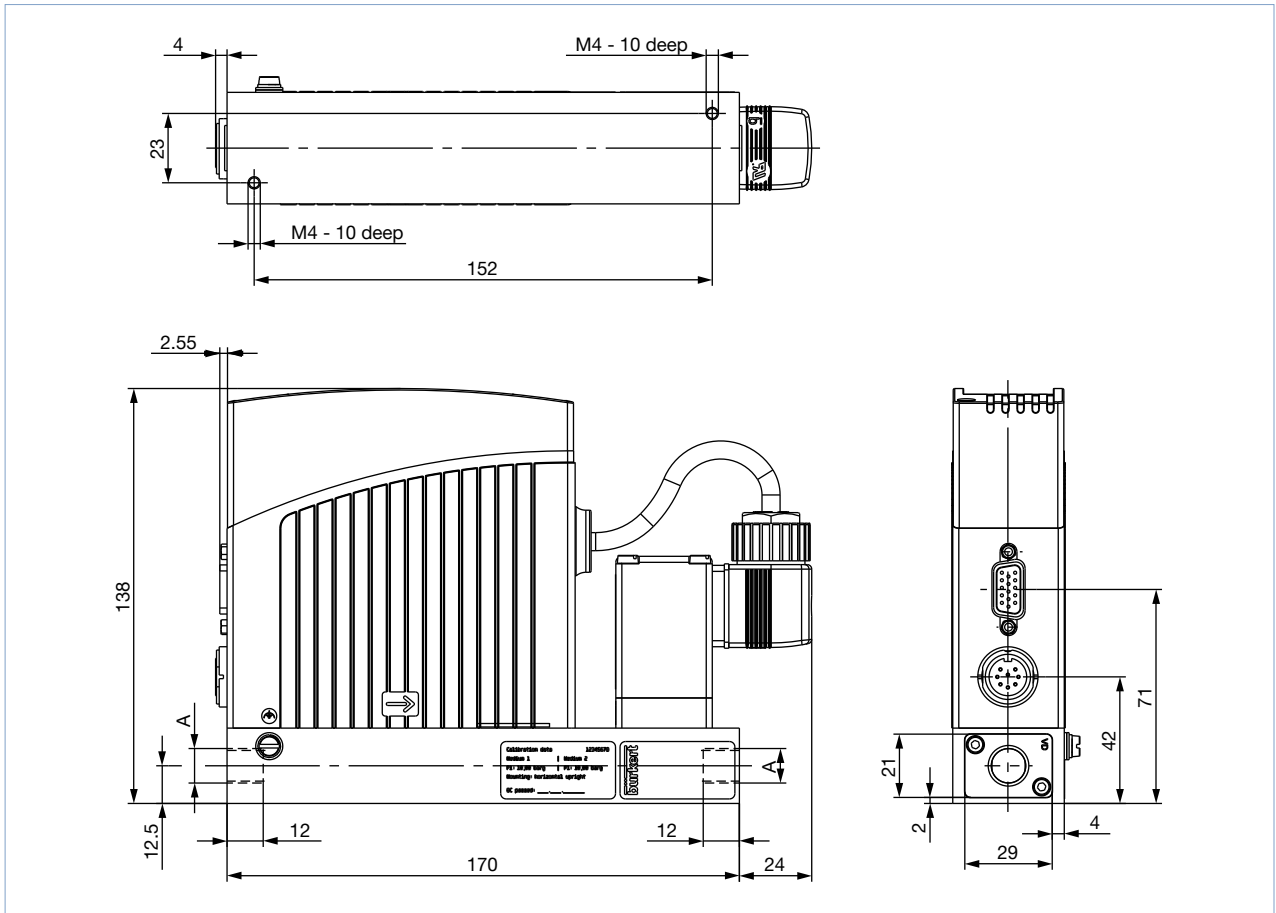

4. Device/Process connections

4.1. Analogue version/Fieldbus version

Note:

- Optional Pin 7 and 8 with bus version as transmitter input possible.
- The cable length for RS232/actual value signal is limited to 30 meters.

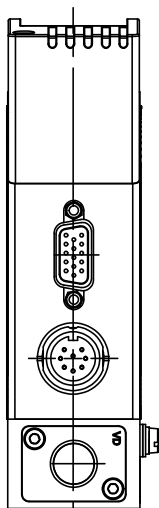

Socket D-Sub HD15	Pin	Assignment	
		Analogue control unit	Bus control
	1	Set value input +	Not connected
	2	Set value input GND	Not connected
	3	Actual value output +	Not connected
	4	Binary input 2	
	5	12 V output (only for internal company use)	
	6	RS232 TxD (direct connection to computer)	
	7	Binary input 1	
	8	GND (for binary inputs)	
	9	only company internal use (do not connect!)	
	10	12 V output (only for internal company use)	
	11	12 V output (only for internal company use)	
	12	Binary input 3	
	13	Actual value output GND	Not connected
	14	RS232 RxD (direct connection to computer)	
	15	DGND (for RS232-interface)	

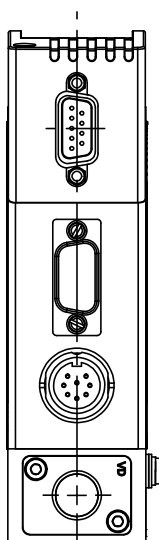

Socket M16, round, 8 pin	Pin	Assignment
	1	24 V-supply +
	2	Relay 1 – reference contact
	3	Relay 2 – reference contact
	4	Relay 1 – normally closed
	5	Relay 1 – normally open
	6	24 V-supply GND
	7	Relay 2 – normally open
	8	Relay 2 – normally closed

Socket D-Sub 9 pin (only with fieldbus version)	Pin	Assignment	
		PROFIBUS DP	CANopen
	1	Shield	Shield
	2	Not connected	CAN-L data line
	3	RxD/TxD - P (B-line)	GND
	4	RTS (control signal for repeater)	Not connected
	5	GND	Not connected
	6	VDD (only for termination resistor)	Not connected
	7	Not connected	CAN-H data line
	8	RxD/TxD - N (A-line)	Not connected
	9	Not connected	Not connected

DTS 1000011287 EN Version: R Status: RL (released | freigegeben | valide) printed: 25.06.2021

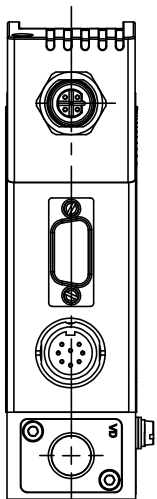

PROFIBUS DP – socket B-coded M12 (DPV1 max. 12 Mbaud)	Pin	Assignment
	1	VDD (only for termination resistor)
	2	RxD/TxD – N (A-line)
	3	DGND
	4	RxD/TxD – P (B-line)
	5	Not connected

CANopen – Plug A-coded M12	Pin	Assignment
	1	Shield
	2	Not connected ^{1.)}
	3	DGND
	4	CAN_H
	5	CAN_L

1.) Optional configuration with 24 V DC possible for power supply via fieldbus connector. With this no power supply connection on round M16 plug needed.

5. Product operation

5.1. Measuring principle

The mass flow sensor operates according to a thermal principle which has the advantage of providing the mass flow which is independent on pressure and temperature.

A small part of the total gas stream is diverted into a small, specifically designed bypassing channel which ensures laminar flow conditions. The sensor element is a chip immersed into the wall of this flow channel. The chip, produced in MEMS technology, contains a heating resistor and two temperature sensors (thermopiles) which are arranged symmetrically upstream and downstream of the heater. The differential voltage of the thermopiles is a measure of the mass flow rate passing the flow sensor. The calibration procedure effectuates a unique assignment of the sensor signal to the total flow rate through the device.

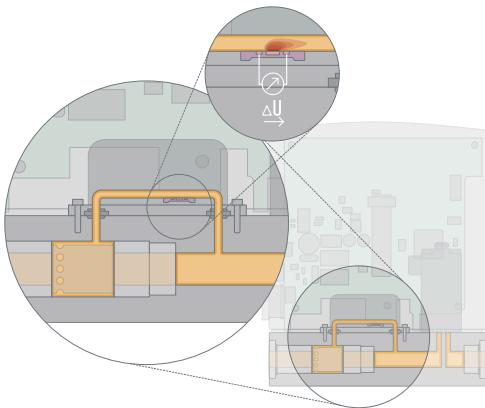

5.2. Flow characteristic

Nominal flow range of typical gases

Note:

- $Q(\text{Gas}) = f \times Q(\text{N}_2)$
- When using the gas factors, measurement errors may occur that are outside the data sheet specification. For applications requiring high accuracy, calibration under field conditions is recommended.
- Furthermore, the media compatibility of the sealing materials of the MFM should be checked before use with another gas.

Gas	Min. Q_{Nom}	Max. Q_{Nom}
	[l _N /min]	[l _N /min]
Argon	0.01	80
Helium	0.01	500
Carbon dioxide	0.02	40
Air	0.01	80
Methane	0.01	80
Oxygen	0.01	80
Nitrogen	0.01	80
Hydrogen	0.01	500

6. Ordering information

6.1. Bürkert eShop – Easy ordering and quick delivery



Bürkert eShop – Easy ordering and fast delivery

You want to find your desired Bürkert product or spare part quickly and order directly? Our online shop is available for you 24/7. Sign up and enjoy all the benefits.

[Order online now](#)

6.2. Recommendation regarding product selection

Note:

Please use the „**Product Enquiry Form**“ at the end of this document for unit design details and send us a copy of the enquiry with information about the application.

For the proper choice of the actuator orifice within the MFC, not only the required maximum flow rate Q_{Nom} , but also the pressure values directly before and after the MFC (p_1 , p_2) at this flow rate Q_{Nom} should be known. In general, these pressures are not the same as the overall inlet and outlet pressures of the whole plant, because usually there are additional flow resistors (tubing, additional shut-off valves, nozzles etc.) present both before and after the controller.

Please use the „**Product Enquiry Form**“ at the end of this document to indicate the pressures directly before and after the MFC. If these should be unknown or not accessible to a measurement, estimates are to be made by taking into account the approximate pressure drops over the flow resistors before and after the MFC, respectively, at a flow rate of Q_{Nom} . In addition, please quote the maximum inlet pressure $p_{1 \text{ max}}$ to be encountered. This data is needed to make sure the actuator is able to provide a close-tight function within all the specified modes of operation.

6.3. Bürkert product filter



Bürkert product filter – Get quickly to the right product



















You want to select products comfortably based on your technical requirements? Use the Bürkert product filter and find suitable articles for your application quickly and easily.

[Try out our product filter](#)

6.4. Ordering chart accessories

Note:

The adapters serve mainly for initial operation or diagnosis. Those are not obligatory for continuous operation.

Description	Article no.
Connections/Cables	
Round plug M16, 8 pin (solder connection)	918299 
Round plug M16, 8 pin with 5 m cable	787733 
Round plug M16, 8 pin with 10 m cable	787734 
Plug D-Sub HD15, 15 pin with 5 m cable	787735 
Plug D-Sub HD15, 15 pin with 10 m cable	787736 
Adapters^{1.)}	
RS232 adapter for connection to a computer, connection with an extension cable (Article no. 917039)	654757 
Extension cable for RS232 9 pin socket/plug 2 m	917039 
RS422 adapter (RS485 compatible)	666370 
USB adapter	670696 
USB connection cable 2 m	772299 
Adapter for manual setting of bus address	667525 
Communication software Mass Flow Communicator	LINK ▶
Accessories for Fieldbus	
PROFIBUS-DP (B-coded)	
Plug M12 ^{2.)}	918198 
Socket M12 (coupling) ^{2.)}	918447 
Y-junction ^{2.)}	902098 
T-junction	918531 
Termination resistor	902553 
GSD-File (PROFIBUS), EDS-File (CANopen)	LINK ▶
CANopen (A-coded)	
Plug M12 ^{2.)}	917115 
Socket M12 (coupling) ^{2.)}	917116 
Y-Stück ^{2.)}	788643 
T-junction	On request
Termination resistor	On request
GSD-File (PROFIBUS), EDS-File (CANopen)	LINK ▶

1.) The adapters serve mainly for initial operation or diagnosis. Those are not obligatory for continuous operation.

2.) The M12 single connectors as listed here are not suitable for their simultaneous use with the Y-piece for reasons of space. Please always use at least one commercially available overmoulded cable whose connector is usually smaller.

6.5. Adapter sketch

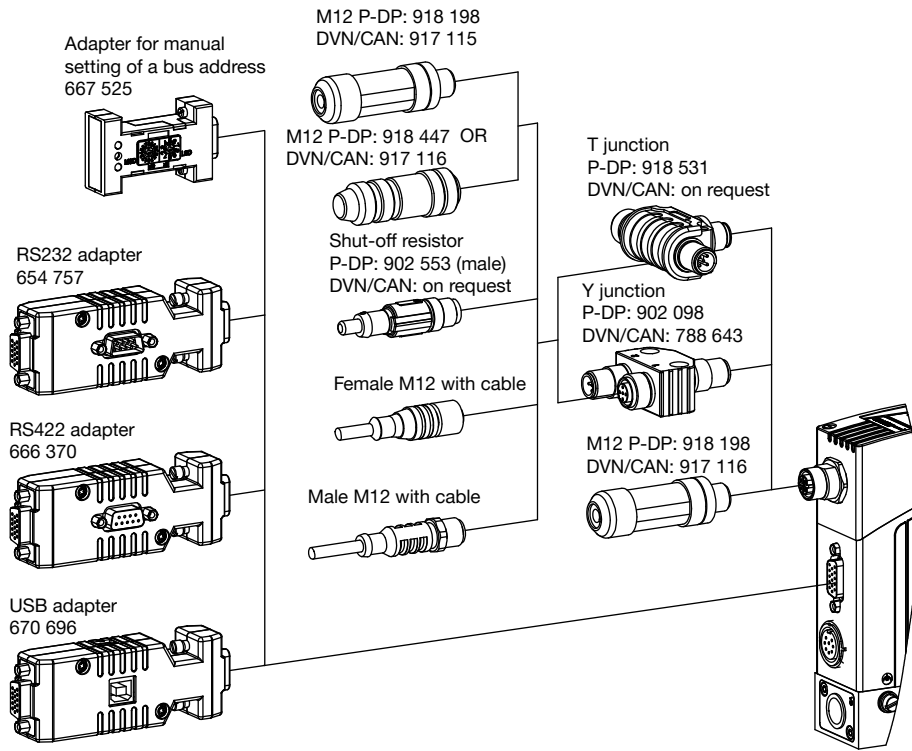

DTS 1000011287 EN Version: R Status: RL (released | freigegeben | valide) printed: 25.06.2021

Bürkert – Close to You

For up-to-date addresses
please visit us at
www.burkert.com

DTS 1000011287 EN Version: R Status: RL (released | freigegeben | validé) printed: 25.06.2021



Product Enquiry Form - Mass Flow Controller For Gases

Thank you for your interest in our products! In order to provide you with optimum advice, please fill out the following form and send it to your **Bürkert representative** or e-mail address: info@burkert.com. All information submitted will of course be kept strictly confidential.

Please fill in the **required fields!** *

*Note: The interactive functions of this PDF may be restricted depending on the PDF reader used.

Personal Information			
Company		Contact person	
Customer no.		Department	
Street		Postcode / Town	
Telephone no.		Email	

Delivery			
MFC Application	MFM Application	Quantity	Required delivery date

Medium data			
Type of gas or gas mixture			
Medium temperature		°C /	°F
Ambient temperature		°C /	°F

Fluidic data					
Flow range Q_{Nom}		Min.		Max.	unit Ref. N ^{1.)} Ref. S ^{1.)}
Inlet pressure at Q_{Nom} ^{2.)}	p_1	=		barg ^{3.)}	
Outlet pressure at Q_{Nom}	p_2	=		barg ^{3.)}	
Max. inlet pressure	p_{1max}	=		barg ^{3.)}	
Port connection	Compression fitting		Subbase	Vacuum fitting	
	Thread:		G (DIN ISO 228/1)	NPT (ANSI B1.2)	
			1/4" 3/8"	1/2" 3/4"	1"
Installation	horizontal, valve upright			vertical, upward flow	
	horizontal, valve horizontal			vertical, downward flow ^{4.)}	

1.) Reference conditions: Ref. N: T=0°C, P=1,013 bar(a); Ref. S: T=20°C, P=1,013 bar(a)

2.) Corresponds to the calibration pressure

3.) Please indicate all pressure values as overpressure to atmospheric pressure [barg] (g = relative pressure)

4.) Possible reduction of the setting range to 1:10 for a vertical downwards flow

Material specifications		
Body	Aluminium	Stainless steel
Seals	FKM	EPDM

Electrical data				
IP protection	Yes (IP65)		No (IP20 or better)	
Control / Communication Note: Please choose one of the following options!	Normsignal	CANopen/büS	PROFIBUS DP	Industrial Ethernet
	0 ... 5 V	CANopen		PROFINET
	0 ... 10 V	büS		Ethernet IP
	0 ... 20 mA			Modbus TCP
	4 ... 20 mA			EtherCAT
Connection Note: Please choose one of the following options!	D Sub socket	M12 socket	D Sub socket	(RJ45 always standard)
	Terminal block	Terminal block	M12 socket	

Approvals / Conformities
UL
ATEX II Cat. 3 G/D, IECEx
USP Class VI conformity
FDA conformity
EG 1935/2004 conformity

Additional Requirements / Comment

DTS 1000011287 EN Version: R Status: RL (released | freigegeben | validé) printed: 25.06.2021