

## Modular process valve cluster - distribution and collecting



- Valve cluster ready for installation
- Compact design without any potential leakage
- No assembly effort
- No piping between the valves needed
- Trusted actuators for simple automation

Type 8840 can be combined with...



**Type 6012**  
Plunger valve

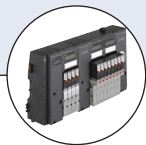

**Type 8647**  
AirLINE SP



**Type 8697**  
Pneumatic control  
unit



**Type 8691**  
Control head



**Type 8695**  
Control head

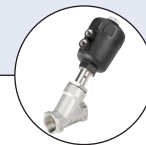

**Type 2000**  
Angle seat valve

Type 8840 comes with ready to install modules of tried and tested Bürkert process valves. The valve cluster, based on a modular valve body, allows different configurations. The individual parts are joined hermetically tight and in a very compact way. No installation effort for pipework, fittings or sealings is needed.

For the sizes DN20 (¾") and DN25 (1") orbital welding is used. The smaller variants in DN10 are threaded together using trusted graphite seals. To avoid dangerous water hammer, all valves have the flow direction below the seat. This is made possible by the two variants for the fluidic main function distribution and collecting, mixing or feed.







Depending on the requirement and preferred type of automation, it is possible to choose from different actuator variants. The robust CLASSIC actuators (in stainless steel or plastic) are controlled by a central valve island or by a pilot valve. The proven ELEMENT actuators allow a simple decentralized automation by using intelligent control heads. Furthermore it is possible to expand the system by using continuous control valves, sensors, customer specific pipework or further accessories.

Technical data	
<b>Orifice</b>	DN10 - threaded DN20, DN25 - welded
<b>Line connections</b>	Thread: G ¾ to G 1, NPT ¾ to NPT 1 Weld ends: ISO 4200 (on request) Clamp: DIN 32676/Series B (on request)
<b>Body material</b>	Stainless steel precision cover 316L (CF3M)
<b>Nominal pressure</b>	PN25 (housing)
<b>Actuator material</b>	INOX DN10: Stainless steel (on request) CLASSIC DN20, DN25: PA (PPS on request) ELEMENT DN20, DN25: Actuator PPS, stainless steel cover 1.4561 (316Ti)
<b>Seal material</b>	PTFE
<b>Medium</b>	Water, alcohols, oils, fuels, hydraulic fluid, saline solutions, alkalis, organic solvents, vapour
<b>Viscosity</b>	Max. 600 mm <sup>2</sup> /s
<b>Spindle packing</b>	PTFE seal with spring compensation
<b>Medium temperature</b>	-10 to +180 °C
<b>Ambient temperature</b>	INOX DN10: 0 to +60 °C CLASSIC DN20, DN25: -10 to +60 °C (PA actuator) +5 to +140 °C (PPS actuator) ELEMENT DN20, DN25: 0 to +60 °C
<b>Control media</b>	Neutral gases, air
<b>Max. pilot pressure</b>	10 bar
<b>Pilot air port</b>	INOX DN10: Female elbow fitting (hose Ø <sup>4</sup> ) CLASSIC DN20, DN25: G ¼ ELEMENT DN20, DN25: Push-in 6/4
<b>Control function</b>	CFA (closed by spring force) CFB (opened by spring force) on request

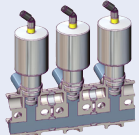
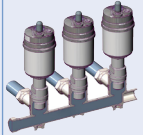
## Technical data, continued

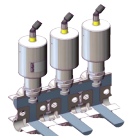

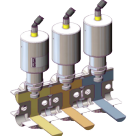
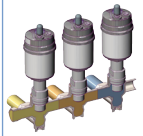
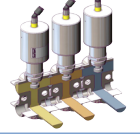
<b>Number of valves</b> DN10 (threaded) DN20, DN25 (welded)	2...9 (clusters with larger number of valves on request ) 2...5 (clusters with larger number of valves on request )
<b>Approvals, conformities</b> on request	ATEX FDA EC Regulation 1935/2004 SIL

## Further technical data

Function	Description of application	DN10 representation	DN15, DN20, DN25 representation
	Distributing: Originating from an inlet, the valve block distributes the medium to several consumers.		
	Collecting: Originating from several consumers, the medium can be collected.		
	Mixing: Various medium, e.g. hot and cold water or a range of chemicals, can be mixed.		
	Feeding: Various medium, e.g. a range of cleaning media, can be supplied to a consumer alternately.		

**Attention!**

For liquid medium, the valve flow direction should always be below seat, otherwise there is a risk of waterhammer!

Actuator version	Orifice [mm]	Actuator size [mm]	K <sub>v</sub> value water [m <sup>3</sup> /h] <sup>1)</sup>	Minimum pilot pressure CFA [bar]	Max. operating pressure up to 180 °C	
					CFA [bar]	CFB [bar]
	10	32	2.1	5.5	16	16
	20	50	6.8	3.9	11	16
	25	63	11.5	4.2	11	16
	20	50	6.8	5.2	16	16
	25	70	12.1	5.0	16	16

<sup>1)</sup> Max. K<sub>v</sub> value of a valve slot. The value may drop when several valve slots are actuated simultaneously.

**Flow:** K<sub>v</sub> value water (m<sup>3</sup>/h): Measurement at +20 °C, 1 bar at the valve inlet and free outlet

**Pressure data (bar):** Overpressure with respect to atmospheric pressure

## Material data

INOX actuator DN10

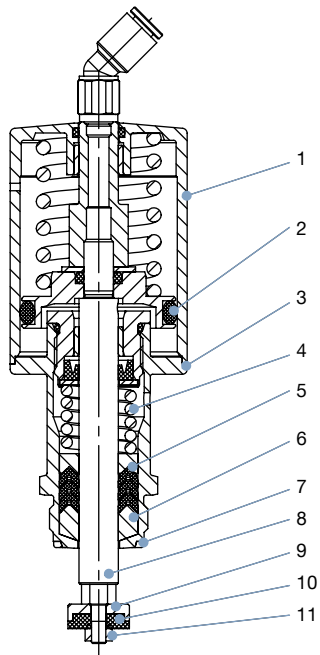

1	Actuator	Stainless steel 1.4404
2	Piston seal	FPM
3	Pipe	Stainless steel 1.4404
4	Spring	1.4310
5	Spindle seal	PTFE
6	Wiper	PTFE
7	Seal	Graphite
8	Spindle	Stainless steel 1.4404
9	Seal retainer	Stainless steel 1.4404
10	Seal	PTFE
11	Centre alignment	Stainless steel 1.4404

CLASSIC actuator DN20, DN25

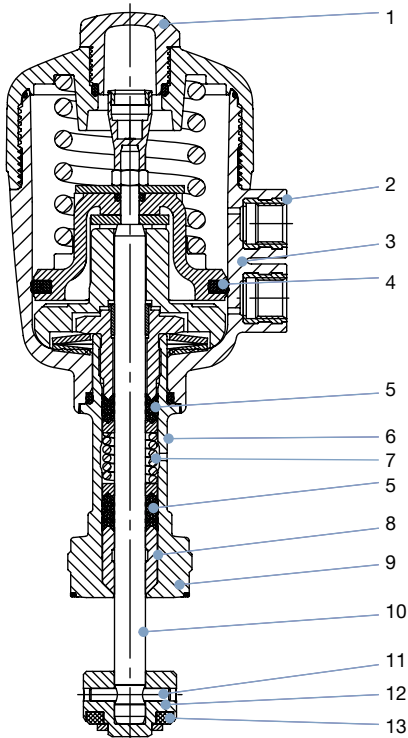

1	Transparent cap	PC (PSU for PPS actuator)
2	Pilot air ports	Stainless steel 1.4305
3	Actuator	PA (PPS on request)
4	Piston seal	NBR (FKM for PPS actuator)
5	Spindle seal	PTFE (FKM on request)
6	Pipe <sup>1)</sup>	Stainless steel 1.4401 / Stainless steel 316L <sup>2)</sup>
7	Spring	Stainless steel 1.4310
8	Wiper	PTFE
9	Nipple <sup>2)</sup>	Stainless steel 1.4401 / Stainless steel 316L <sup>2)</sup>
10	Spindle	Stainless steel 1.4401
11	Pin	Stainless steel 1.4401
12	Swivel plate	Stainless steel 1.4401
13	Seal	PTFE (NBR, FKM, EPDM on request)

<sup>1)</sup> One-piece for actuator size 63 mm to 125 mm

<sup>2)</sup> For actuator size 63 mm

## Material data, continued



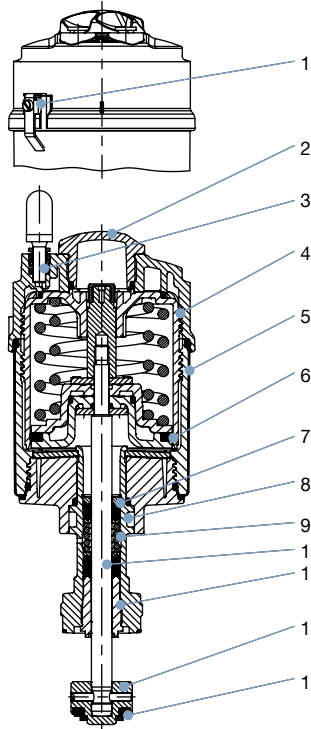













ELEMENT actuator DN20, DN25



















1	Ground terminal	Stainless steel 1.4301/1.4305 only for ATEX version
2	Optical position indicator	Transparent cap polysulphone PSU
3	Pilot air ports	Plug-in hose connector PP (standard) On request: Thread G 1/8 stainless steel 1.4305
4	Actuator	PPS
5	Cover	Stainless steel 1.4561 (316Ti)
6	Piston seal	FKM
7	Spring	Stainless steel 1.4310
8	Pipe	Stainless steel 1.4401 (316)/1.4404 (316L)
9	Spindle seal	PTFE
10	Spindle	Stainless steel 1.4401 (316)/1.4404 (316L)
11	Spindle guide	PEEK
12	Swivel plate	Stainless steel 1.4401 (316)/1.4404 (316L)
13	Seal	PTFE

## Ordering chart (further versions on request)

## Modular process valve cluster distributor – G threaded connection

Actuator version	Orifice [mm]	Actuator size [mm]	Threaded connection	Minimum pilot pressure [bar]	Operating pressure up to 180 °C [bar]	Number of valves	Article no.	
	20	50	G 3/4	3.9	11	2	283906 	
						3	283908 	
						4	283909 	
						5	283910 	
						25	63	G 1
						3	283942 	
						4	283943 	
						5	283944 	
	20	50	G 3/4	5.2	16	2	283911 	
						3	283912 	
						4	283913 	
							5	283914 
	25	70	G 1	5.0	16	2	283945 	
						3	283946 	
						4	283947 	
						5	283948 	

## Modular process valve cluster distributor – NPT threaded connection

Actuator version	Orifice [mm]	Actuator size [mm]	Threaded connection	Minimum pilot pressure [bar]	Operating pressure up to 180 °C [bar]	Number of valves	Article no.	
	20	50	NPT 3/4	3.9	11	2	283915 	
						3	283916 	
						4	283917 	
						5	283918 	
						25	63	NPT 1
						3	283950 	
						4	283951 	
						5	283952 	
	20	50	NPT 3/4	5.2	16	2	283919 	
						3	283920 	
						4	283922 	
							5	283923 
	25	70	NPT 1	5.0	16	2	283953 	
						3	283954 	
						4	283955 	
						5	283956 	

**i** Further versions on request

**Orifice**  
DN10 threaded, DN15 welded



















**Material**  
Seal between body and actuator PTFE (FDA compliant version)



















**Line connection**  
Weld end acc. to ISO 4200, clamp acc. to DIN 32676/Series B

## Ordering chart (further versions on request)

## Modular process valve cluster collector – G threaded connection

Actuator version	Orifice [mm]	Actuator size [mm]	Threaded connection	Minimum pilot pressure [bar]	Operating pressure up to 180 °C [bar]	Number of valves	Article no.
	20	50	G 3/4	3.9	11	2	283924 
						3	283925 
						4	283926 
						5	283927 
						25	63
3	283960 						
4	283961 						
5	283962 						
	20	50	G 3/4	5.2	16	2	283928 
						3	283929 
						4	283930 
	25	70	G 1	5.0	16	5	283931 
						2	283963 
						3	283964 
	4	283965 					
	5	283966 					

## Modular process valve cluster collector – NPT threaded connection

Actuator version	Orifice [mm]	Actuator size [mm]	Threaded connection	Minimum pilot pressure [bar]	Operating pressure up to 180 °C [bar]	Number of valves	Article no.
	20	50	NPT 3/4	3.9	11	2	283932 
						3	283933 
						4	283934 
						5	283935 
						25	63
3	283969 						
4	283971 						
5	283972 						
	20	50	NPT 3/4	5.2	16	2	283936 
						3	283937 
						4	283938 
	25	70	NPT 1	5.0	16	5	283939 
						2	283973 
						3	283974 
	4	283975 					
	5	283976 					

**i** Further versions on request**Orifice**

DN10 threaded, DN15 welded

**Material**

Seal between body and actuator PTFE (FDA compliant version)

**Line connection**

Weld end acc. to ISO 4200, clamp acc. to DIN 32676/Series B

Dimensions [mm]

Type 8840 INOX DN10

Distributor (mm)

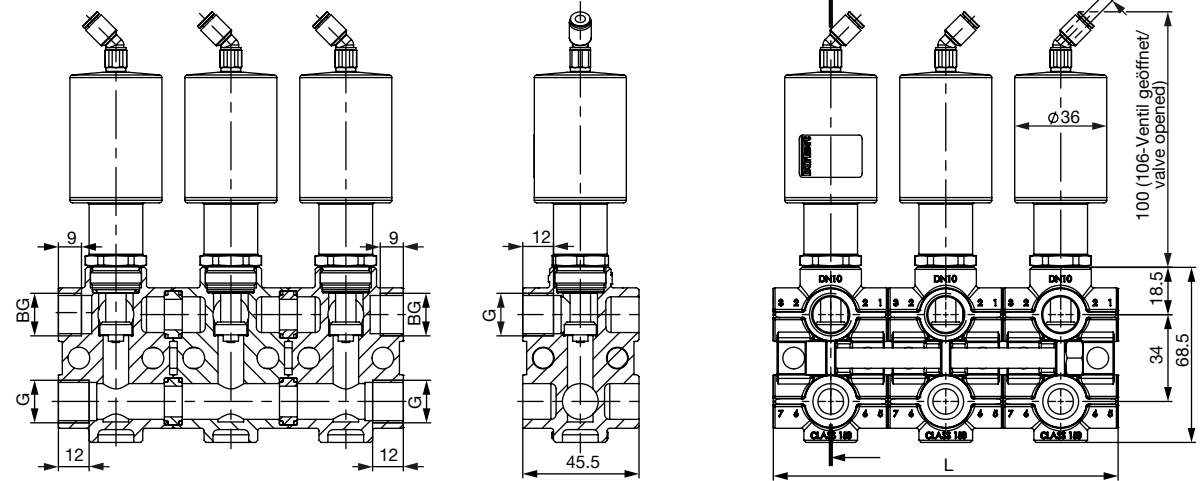

Type 8840 INOX DN10

Collector (mm)

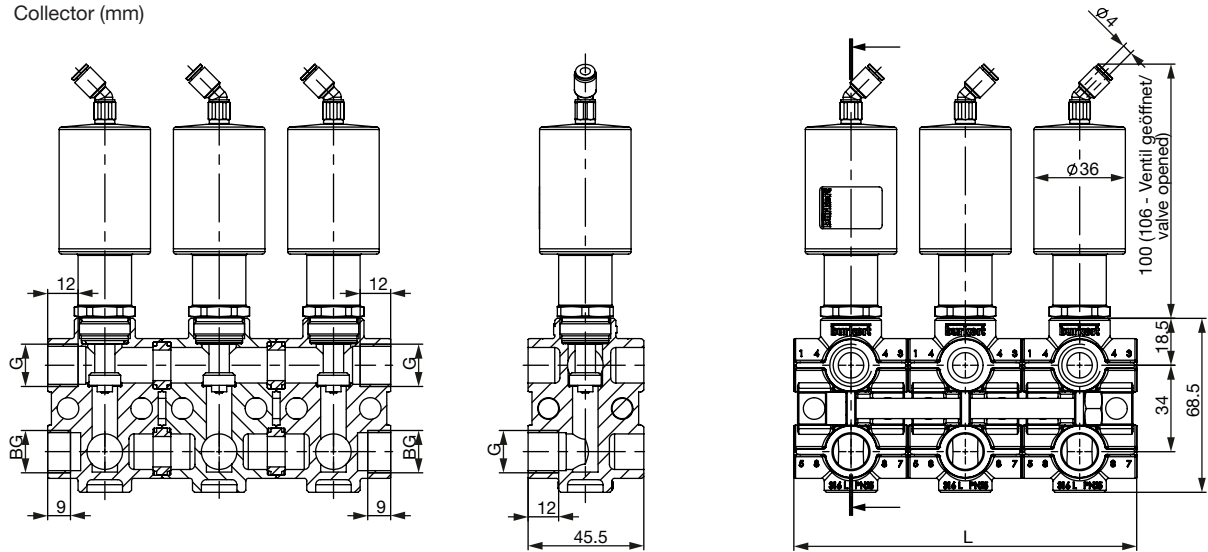

DN [mm]	Actuator size [mm]	Thread G	Thread BG <sup>1)</sup>	Number of valves	L [mm]
10	32	G 3/8 or NPT 3/8	G 3/8 or NPT 3/8	2	90
10	32	G 1/2 or NPT 1/2	G 1/2 or NPT 1/2	3	135
10	32	G 3/4 or NPT 3/4	G 3/4 or NPT 3/4	4	180
10	32	G 1 or NPT 1	G 1 or NPT 1	5	225
10	32	G 1 1/4 or NPT 1 1/4	G 1 1/4 or NPT 1 1/4	6	270
10	32	G 1 1/2 or NPT 1 1/2	G 1 1/2 or NPT 1 1/2	7	315
10	32	G 2 or NPT 2	G 2 or NPT 2	8	360
10	32	G 2 1/2 or NPT 2 1/2	G 2 1/2 or NPT 2 1/2	9	405

<sup>1)</sup>Threads can only be used to attach the valve block, e.g. to a mounting plate or a frame.

Dimensions [mm] continued

Type 8840 CLASSIC DN20, DN25

Distributor (mm)

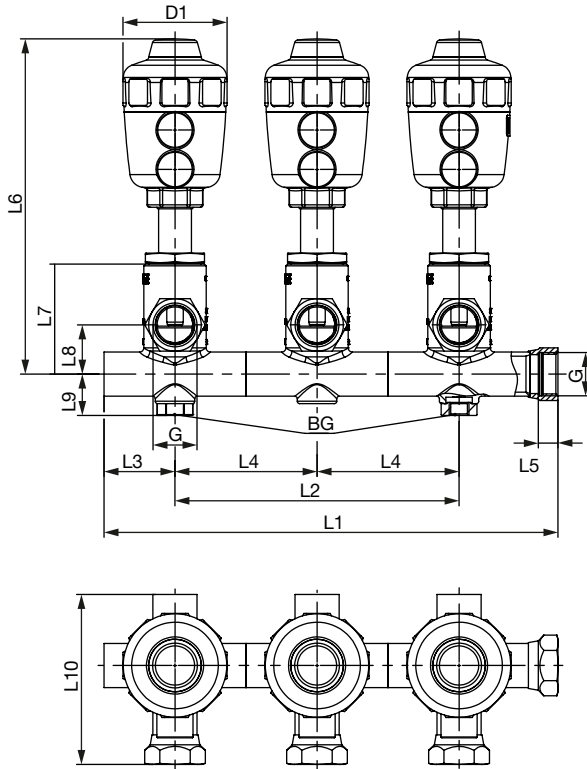

DN [mm]	Actuator size [mm]	Thread G	Thread BG <sup>1)</sup>	Number of valves	L1	L2	L3	L4	L5	L6	L7	L8	L9	L10	D1
20	50	G ¾ or NPT ¾	M12 / 8 depth	2	190	86.5	43.3	86.5	12	205	67	30	25	104	63
				3	277	173									
				4	363	259.5									
				5	450	346									
25	63	G 1 or NPT 1	M16 / 13 depth	2	228	104	52	104	14	253	83	41	32	124	80
				3	332	208									
				4	436	312									
				5	540	416									

<sup>1)</sup>Threads can only be used to attach the valve block, e.g. to a mounting plate or a frame.



Dimensions [mm] continued

Type 8840 CLASSIC DN20, DN25

Collector (mm)

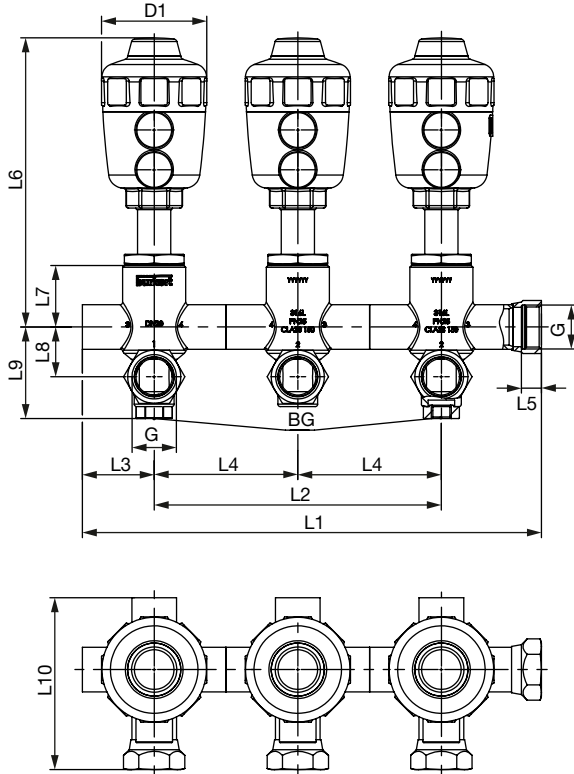

DN [mm]	Actuator size [mm]	Thread G	Thread BG <sup>1)</sup>	Number of valves	L1	L2	L3	L4	L5	L6	L7	L8	L9	L10	D1
20	50	G ¾ or NPT ¾	M12 / 8 depth	2	190	86.5	43.3	86.5	12	175	37	30	55	104	63
				3	277	173									
				4	363	259.5									
				5	450	346									
25	63	G 1 or NPT 1	M16 / 13 depth	2	228	104	52	104	14	212	42	41	73	124	80
				3	332	208									
				4	436	312									
				5	540	416									

<sup>1)</sup>Threads can only be used to attach the valve block, e.g. to a mounting plate or a frame.

Dimensions [mm] continued

Type 8840 ELEMENT DN20, DN25

Distributor (mm)

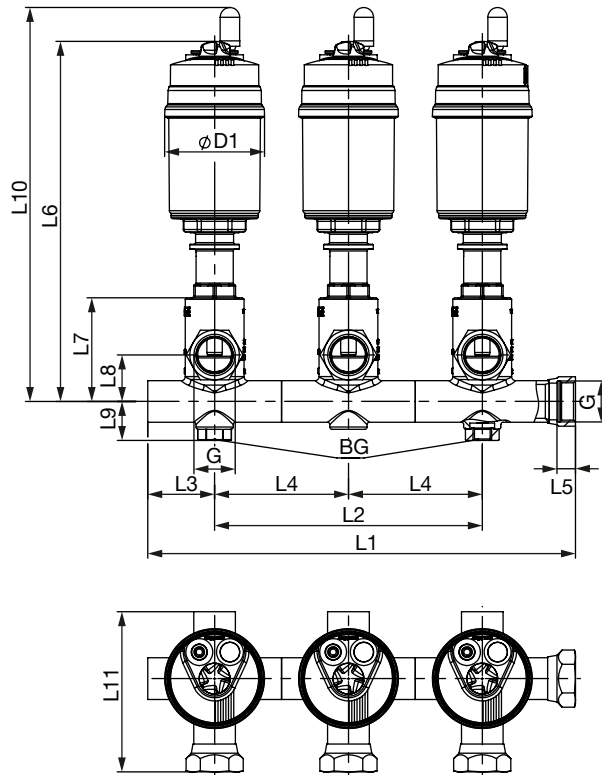

DN [mm]	Actuator size [mm]	Thread G	Thread BG <sup>1)</sup>	Number of valves	L1	L2	L3	L4	L5	L6	L7	L8	L9	L10	L11	D1
20	50	G ¾ or NPT ¾	M12 / 8 depth	2	190	86.5	43.3	86.5	12	233	67	30	25	255	104	65
				3	277	173										
				4	363	259.5										
				5	450	346										
25	63	G 1 or NPT 1	M16 / 13 depth	2	228	104	52	104	14	261	83	41	32	281	124	91
				3	332	208										
				4	436	312										
				5	540	416										

<sup>1)</sup>Threads can only be used to attach the valve block, e.g. to a mounting plate or a frame.

Dimensions [mm] continued

Type 8840 ELEMENT DN20, DN25

Collector (mm)

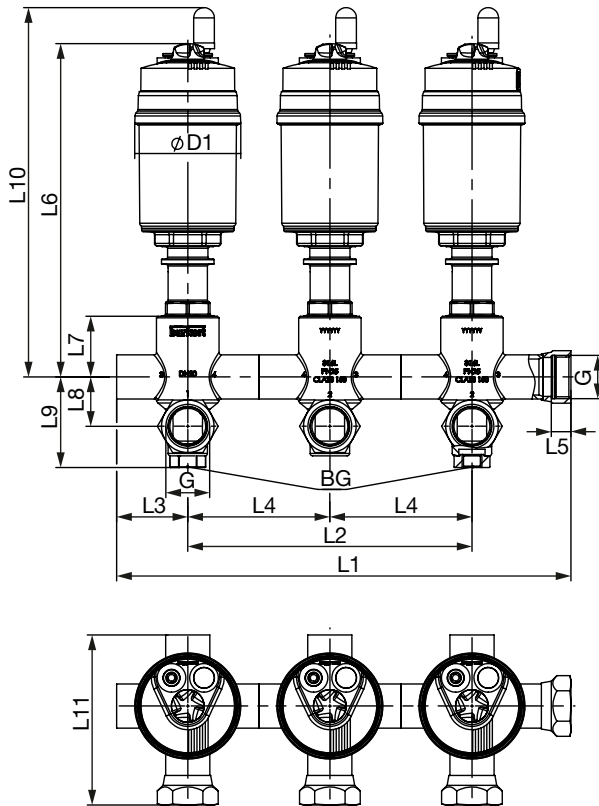

DN [mm]	Actuator size [mm]	Thread G	Thread BG <sup>1)</sup>	Number of valves	L1	L2	L3	L4	L5	L6	L7	L8	L9	L10	L11	D1
20	50	G ¾ or NPT ¾	M12 / 8 depth	2	190	86.5	43.3	86.5	12	203	37	30	55	225	104	65
				3	277	173										
				4	363	259.5										
				5	450	346										
25	63	G 1 or NPT 1	M16 / 13 depth	2	228	104	52	104	14	220	42	41	73	240	124	91
				3	332	208										
				4	436	312										
				5	540	416										

<sup>1)</sup>Threads can only be used to attach the valve block, e.g. to a mounting plate or a frame.

Specification key

Example

8840 20 SA43 G 3 S

Specification key

Please make a selection

8840 [ ] [ ] [ ] [ ] [ ] [ ]

Orifice DN (mm)
10
15
20
25

Function	
S	Collector
V	Distributor

Port connection	
GM83	G ½ threaded connection (for orifice DN10)
NM83	NPT ¾ threaded connection (for orifice DN10)
GM84	G ½ threaded connection (for orifice DN15)
NM84	NPT ½ threaded connection (for orifice DN15)
SA42	Welded connection Ø 21.3 × 1.6 (for orifice DN15)
TC42	Clamped connection Ø 21.3 × 1.6 Cl:34 (for orifice DN15)
GM85	G ¾ threaded connection (for orifice DN20)
NM85	NPT ¾ threaded connection (for orifice DN20)
SA43	Welded connection Ø 26.9 × 1.6 (for orifice DN20)
TC43	Clamped connection Ø 26.9 × 1.6 Cl:50.5 (for orifice DN20)
GM86	G 1 threaded connection (for orifice DN25)
NM86	NPT 1 threaded connection (for orifice DN25)
SA44	Welded connection Ø 33.7 × 2 (for orifice DN25)
TC44	Clamped connection Ø 33.7 × 2 Cl:50.5 (for orifice DN25)

Actuator version	
H	INOX (for orifice DN10, DN15)
C	CLASSIC PA (for orifice DN15, DN20, DN25)
D	CLASSIC PPS (for orifice DN15, DN20, DN25)
G	ELEMENT (for orifice DN15, DN20, DN25)

Number of valves	
2	
3	
4	
5	
6	
7	
8	
9	

**More info.**  
For more technical information about this product, click on this box... you will come to our website for this product where you can download the datasheet.

**Standard configuration - request for quotation**

Please complete and return with your request or order to your nearest Bürkert facility

Company	Contact
Customer no.	Department
Street	Tel./Fax
Postcode, town/city	Email

= mandatory fields

Quantity

Required delivery date

**Operating data**

Pipeline DN  PN   
 Pipe material

Process medium

State of medium  Liquid  Vapour  Gas

**Valve data**

Nominal pressure PN   
 Orifice DN   
 Connection  Thread  Weld ends  Clamp  
 Actuator version  INOX  CLASSIC  ELEMENT  
 Pilot pressure  min.  max.  
 ATEX II 2GD mechanical   
 FDA   
 EC Regulation 1935/2004   
 Article no. (if known):

**Specification key**

8840

(automatically transferred from page 12)

**Accessories**

Please click the "More info" box ... You will be redirected to our web page for this product where you can download the respective data sheet.

**CLASSIC**

**Control head / Position feedback**



**More info.**

**Type 8697**  
For actuator sizes Ø 40, 50 and 63 mm

Article no. (if known):

**ELEMENT**

**Control head / Position feedback**



**More info.**

**Type 8691**  
For actuator size Ø 70 mm



**More info.**

**Type 8695**  
For actuator size Ø 50 mm

Article no. (if known):

**Pneumatic control / Position feedback**



**More info.**

**Type 8690**  
For actuator size Ø 70 mm



**More info.**

**Type 8697**  
For actuator size Ø 50 mm

Article no. (if known):

## Modular platform for process control and regulation

### Combination options based on Type 8840 (individual customer solutions available on request)

Type 8840 enables Bürkert to provide quickly and efficiently all common valve assemblies pre-configured for distributing and collecting functions (for other possible variations, see illustrations on pages 7 - 11).

Furthermore, individual customer solutions are available on request.

Thanks to the modular platform for process control and regulation, various application-specific requirements can be met. The modular platform for process control and regulations also enables every combination option when selecting the actuator, control and measuring principle and the fluid functions:

Actuator variations:	Electromotive, pneumatic, manual
Control, regulation principle:	On/Off, continuous
Sensor variations:	Temperature, pressure, flow

Irrespective of whether the system is to be actuated by an electric motor, pneumatically or manually, Bürkert offers the ideal actuator and control/regulation principle for every requirement. Moreover, the ideal measuring principle can be selected from the extensive sensor range for measuring temperature, pressure and flow rate. They guarantee reliable measurement values and can be easily integrated into the system.

Besides the standard distributing and collecting functions, specified fluid combinations can be achieved.

#### ACTUATOR VARIATIONS



#### HOUSING VARIATIONS



#### SENSOR VARIATIONS

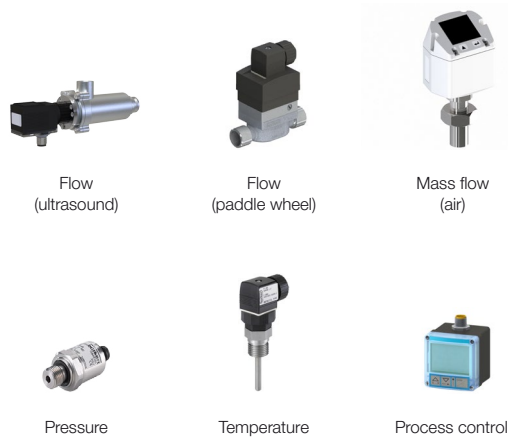

Modular platform for process control and regulation

(individual customer solutions available on request)

ACTUATOR VARIATIONS



Pneumatic  
INOX



Manual

HOUSING



SENSOR VARIATIONS



Pressure



Flow  
(paddle wheel)



Flow  
(ultrasound)





Temperature

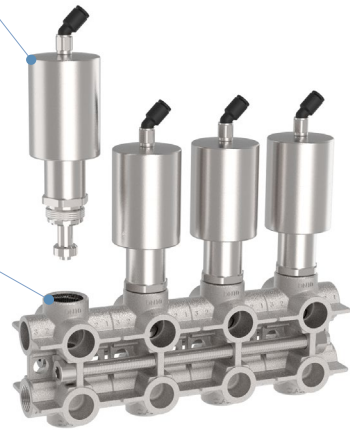

Temperature



## Modular platform for process control and regulation – examples

Valve system	Description of application
	<p><b>Distributing gas in the pharmaceutical and food industry</b> Controlling and regulating process gas (e.g. CO<sub>2</sub> and N<sub>2</sub>) for:</p> <ul style="list-style-type: none"> <li>• Pneumatic conveying</li> <li>• Inertisation</li> <li>• Preservation</li> <li>• Flushing</li> <li>• ...</li> </ul>
	<p><b>Cleaning processes in the pharmaceutical and food industry</b> Distributing cleaning media and water for:</p> <ul style="list-style-type: none"> <li>• Keg cleaning</li> <li>• Filling and packaging machines</li> <li>• Grinding and crushing systems</li> <li>• Container cleaning</li> <li>• ...</li> </ul>
	<p><b>Controlling the temperature of industrial processes</b> Controlling and regulating temperature control processes for:</p> <ul style="list-style-type: none"> <li>• Injection moulding machines</li> <li>• Pressure die casting machines</li> <li>• Temperature control devices</li> <li>• Tools for carbon fibre reinforced components</li> </ul>



**Customised configuration - request for quotation**

▶ Please complete and return with your request or order to your nearest Bürkert facility

Company	Contact
Customer no.	Department
Street	Tel./Fax
Postcode, town/city	Email

**Commercial data**

Project name

Quantity   One-off request  
 Multiple request

**Flow diagram**

*Please provide a schematic sketch*

**Legend (example sketch)**

Seat valve

Medium flow direction

C1, C2, ... Connections - system/block

A1, A2, ... Actuators (valves on block)

C1 ... Cn

A1 ... An

DTS 1000338741 EN Version: E Status: RL (released | freigegeben | valide) printed: 05.02.2020

To find your nearest Bürkert facility, click on the orange box → [www.burkert.com](http://www.burkert.com)

In case of special application conditions,  
please consult for advice.

Subject to alteration.  
© Christian Bürkert GmbH & Co. KG

1811/2\_EU-en\_1000338741