

Inductive positioning system

PMI120-F90-IU2EP-IO-V15

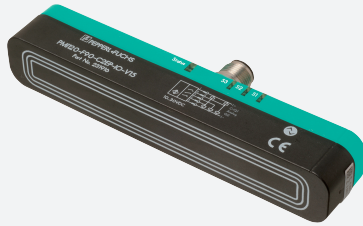

- Parameterization and diagnosis via IO-Link
- Measuring range 0 ... 120 mm
- Parameterisable measuring range
- Analog current or voltage output, programmable
- 2 Push-pull outputs
- Switch points programmable via IO-Link



Dimensions

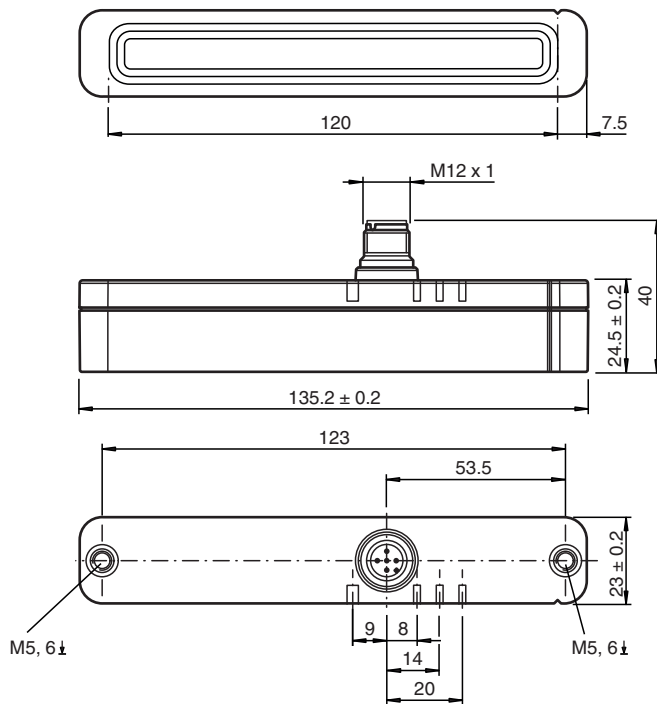

Technical Data

General specifications

Switching element function	Analog current or voltage output, programmable 2 switch outputs, programmable
Object distance	0.5 ... 3 mm , recommended: 1.5 mm
Measurement range	0 ... 120 mm
Linearity range	1 ... 119 mm

Nominal ratings

Operating voltage	U _B	12 ... 30 V DC (13 ... 30 V when analog voltage output is parameterized)
Reverse polarity protection		reverse polarity protected

Release date: 2020-12-14 Date of issue: 2020-12-14 Filename: 315196_eng.pdf

Refer to "General Notes Relating to Pepperl+Fuchs Product Information".

Pepperl+Fuchs Group
www.pepperl-fuchs.com

USA: +1 330 486 0001
fa-info@us.pepperl-fuchs.com

Germany: +49 621 776 1111
fa-info@de.pepperl-fuchs.com

Singapore: +65 6779 9091
fa-info@sg.pepperl-fuchs.com

PF PEPPERL+FUCHS

Technical Data

Linearity error		within measuring range: ± 0.8 mm within linearity range: ± 0.4 mm
Repeat accuracy	R	± 0.1 mm
Resolution		50 μ m
Temperature drift		± 0.5 mm (-25 °C ... 70 °C)
No-load supply current	I_0	≤ 40 mA
Operating voltage indicator		LED green
Functional safety related parameters		
MTTF _d		271 a
Mission Time (T _M)		20 a
Diagnostic Coverage (DC)		0 %
Indicators/operating means		
LED S1		switching state Switching output 1
LED S2		switching state Switching output 2
LED S3		Damping element in the configured analog measuring range
LED STATUS		Status display LED, green/red (Power on, communication/error, missing damping element)
Interface		
Interface type		IO-Link (via C/Q = Pin 4)
Device profile		Smart Sensor
Device ID		0x200403 (2098179)
Transfer rate		COM 2 (38.4 kBaud)
Value range		0000h ... 9600h
Min. cycle time		2.3 ms
Process data width		Process data input: 16 Bit Process data output: none
SIO mode support		yes
Compatible master port type		A
Switching output		
Output type		2 push-pull outputs (can be parameterized), short-circuit-proof, reverse polarity protection, surge-proof
Operating current	I_L	≤ 100 mA / output
Switching window		± 1 mm
Switching hysteresis		0.2 mm
Voltage drop		≤ 3 V
Short-circuit protection		pulsing
Analog output		
Output type		1 current output: 4 ... 20 mA or 1 voltage output: 0 ... 10 V , programmable
Load resistor		current output: ≤ 400 Ω voltage output: ≥ 1000 Ω
Short-circuit protection		voltage output: current limit
Compliance with standards and directives		
Standard conformity		
Standards		EN 60947-5-2:2007 EN 60947-5-2/A1:2012 IEC 60947-5-2:2007 IEC 60947-5-2 AMD 1:2012 EN 60947-5-7:2003 EN61131-9:2013 IEC 60947-5-7:2003 IEC 61131-9:2013
Approvals and certificates		
UL approval		cULus Listed, Class 2 Power Source, Type 1 enclosure
Marine approval		DNVGL TAA00001V2
Ambient conditions		
Ambient temperature		-25 ... 85 °C (-13 ... 185 °F)
Mechanical specifications		

Release date: 2020-12-14 Date of issue: 2020-12-14 Filename: 315196_eng.pdf

Refer to "General Notes Relating to Pepperl+Fuchs Product Information".

Pepperl+Fuchs Group
www.pepperl-fuchs.comUSA: +1 330 486 0001
fa-info@us.pepperl-fuchs.comGermany: +49 621 776 1111
fa-info@de.pepperl-fuchs.comSingapore: +65 6779 9091
fa-info@sg.pepperl-fuchs.com

PEPPERL+FUCHS

Technical Data

Connection type	5-pin, M12 x 1 connector
Degree of protection	IP67 / IP69K
Material	
Housing	PBT, stainless steel 1.4571 , brass, nickel-plated
Target	mild steel, e. g. 1.0037, SR235JR (formerly St37-2)
Mass	113 g

Connection

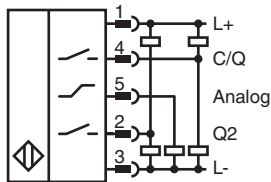

Connection Assignment

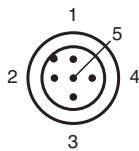

Wire colors in accordance with EN 60947-5-2

1	BN	(brown)
2	WH	(white)
3	BU	(blue)
4	BK	(black)
5	GY	(gray)

Application



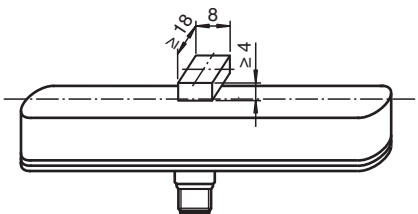

dimensions for the target object:

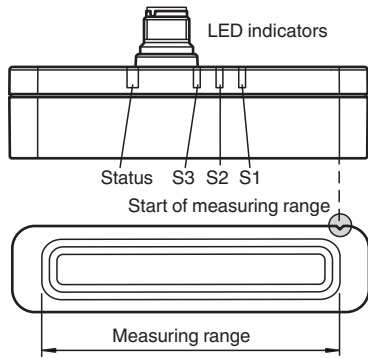

Release date: 2020-12-14 Date of issue: 2020-12-14 Filename: 315196_eng.pdf



Accessories

	BT-F90-W	Damping element for sensors of type F90, F112, and F166; side hole
	MH-F90	Mounting bracket for mounting of F90 sensors
	V15-G-2M-PVC	Female cordset single-ended M12 straight A-coded, 5-pin, PVC cable grey
	V15-W-2M-PVC	Female cordset single-ended M12 angled A-coded, 5-pin, PVC cable grey

Operation

Attention!

If the sensor is supplied via an IO-Link-Master, ensure that the sum of the no-load supply current and operating currents of all sensor outputs does not exceed the maximum current the IO-Link-Master can supply.