

Active infrared scanner

DoorScan-DS-2P-1200

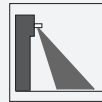

- Moving presence sensor for automatic doors
- SIL 2, certified in accordance with DIN 18650/EN 16005
- Exceptional detection reliability
- Reliable operation with all floor coverings
- Complete protection up to the wall without sensor shutoff
- Additional protection of the main and secondary closing edges
- Tool-free module mounting using snap-in mechanism
- Switchable NPN or PNP outputs

Light curtain for individual protection for automatic doors in accordance with DIN 18650/EN 16005, complete system for a door measuring up to 1200 mm wide, NPN output



Function

DoorScan is a presence sensor for automatic revolving doors. It uses active infrared technology to perform background evaluation. The sensor is suitable for mobile or stationary mounting. Because the emitter and receiver module can be repositioned freely, the field of view can also be adjusted to fit the door width. An interface controls both sides of the door and establishes the link to the door controller. DoorScan meets the requirements of DIN 18650 and is a safety system fulfilling PL d in accordance with DIN EN ISO 13849-1 used in conjunction with a secure door controller that generates and evaluates the test signals.

Dimensions

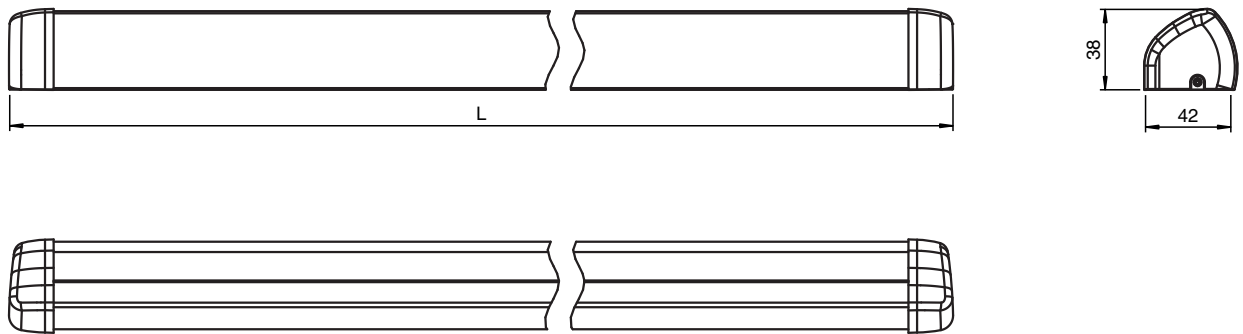

Technical Data

General specifications

Detection range min.	0 ... 1500 mm
Detection range max.	0 ... 3500 mm (Upright CA test body)
Sensing range	1000 mm at installation height of 2100 mm
Light source	IRED 850 nm
Black/White difference (6 %/90 %)	< 2 % at 2000 mm sensor range
Number of beams	10
Operating mode	Background evaluation
Diameter of the light spot	8 cm at 2000 mm sensor range

Functional safety related parameters

Safety Integrity Level (SIL)	SIL 2
Performance level (PL)	PL d
Category	Cat. 2
MTTF _d	112.7 a
Mission Time (T _M)	10 a

Indicators/operating means

Function indicator	Receiver: Red LED: detection, excess gain, fault code Interface: Red LED: detection, excess gain, fault code Yellow LED: teach status Green LED: blank status Green LED: DIP switch status
Control elements	Teach-In key , DIP-switch for selection of operating modes

Electrical specifications

Operating voltage	U _B	24 V DC +/- 20 %
-------------------	----------------	------------------

Release date: 2020-10-08 Date of issue: 2020-10-08 Filename: 299664_eng.pdf

Refer to "General Notes Relating to Pepperl+Fuchs Product Information".

Pepperl+Fuchs Group
www.pepperl-fuchs.com

USA: +1 330 486 0001
fa-info@us.pepperl-fuchs.com

Germany: +49 621 776 1111
fa-info@de.pepperl-fuchs.com

Singapore: +65 6779 9091
fa-info@sg.pepperl-fuchs.com

 PEPPERL+FUCHS

Technical Data

No-load supply current	I_0	max. 200 mA
Power consumption	P_0	4.8 W
Input		
Test input		high level ≥ 15 V low level ≤ 2 V
Control input		Standby active at $U = 11$ V DC at 30 V DC
Output		
Switching type		light on
Signal output		switchable NPN or PNP , short-circuit protected
Switching voltage		max. 30 V DC
Switching current		max. 100 mA
Response time		≤ 52 ms ≤ 200 ms in boost operating mode
Conformity		
Functional safety		ISO 13849-1 ; EN 61508 part1-4
Product standard		EN 12978
Approvals and certificates		
CCC approval		CCC approval / marking not required for products rated ≤ 36 V
Ambient conditions		
Ambient temperature		-30 ... 60 °C (-22 ... 140 °F)
Mechanical specifications		
Housing length L		1200 mm
Mounting height		max. 3500 mm
Degree of protection		IP54 (iwhen mounted)
Connection		Plug-in terminal with 6-wire connection cable
Material		
Housing		Aluminum / PA
Optical face		PC (Polycarbonate)
Mass		approx. 2100 g
Dimensions		(W x H x D) : 42 mm x 1200 mm x 37 mm
General information		
Scope of delivery		Sensor system for hinge side and leading edge side (2 emitter and receiver modules each, 1 interface module, connecting cable, 2 housing profiles and optical covers each, 4 end caps)

Connection Assignment

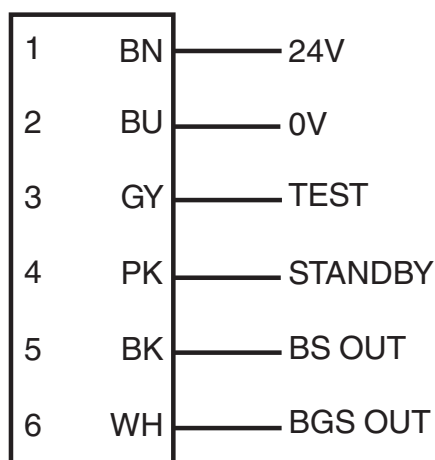





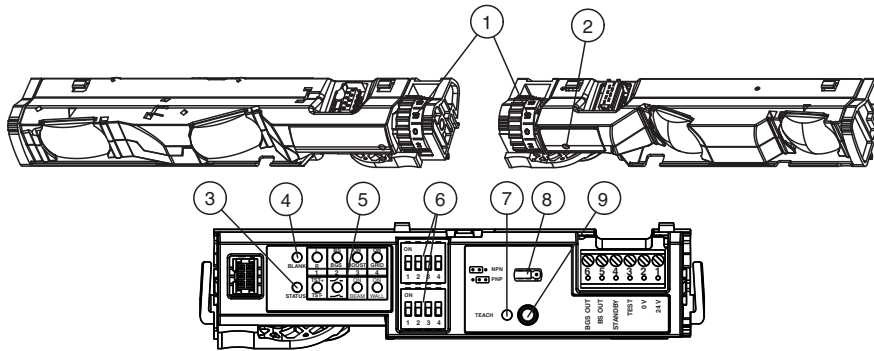





Release date: 2020-10-08 Date of issue: 2020-10-08 Filename: 299664_eng.pdf

Assembly



- | | |
|---|-----------------------------|
| 1 Adjusting wheel for inclination angle | 6 DIP switch - rows 1 and 2 |
| 2 Receiver indicator LED, red | 7 Teach LED, yellow |
| 3 Status LED, red | 8 Jumper |
| 4 Blank LED, green | 9 Teach button |
| 5 DIP LEDs, green | |

Accessories

	DoorScan Weather Cap L1200	All-weather hood for DoorScan® and TopScan series sensing strips
	DoorScan Transfer Loop	Door transition cable to door controller for DoorScan® sensor, including cable sheathing and strain relief
	DoorScan Connection Cable 5p	Connecting cable with 5 plug-in connections for DoorScan®-I/-T/-R modules
	DoorScan Cable BS/BGS	Connecting cable for transition from hinge side to leading edge side
	DoorScan End Caps	End cap set for DoorScan® sensor profile
	TopScan-S Profile L1400	Housing profile TopScan-S
	TopScan-S Cover L1400	Housing cover TopScan-S
	DoorScan Relay Module	Replacement/extension sensor module for installation in the DoorScan® and TopScan sensor profile, multifunction interface module
	DoorScan Adapter	Adapter module for installation in the DoorScan® and TopScan sensor profile, multifunction interface module
	DoorScan Cable Adapter	Adapter module for installation in the DoorScan® sensor profile, multifunction interface module

Release date: 2020-10-08 Date of issue: 2020-10-08 Filename: 299664_eng.pdf

Additional Information

Layout of the sensor system for a door (door hinge side/hinge opposite side)

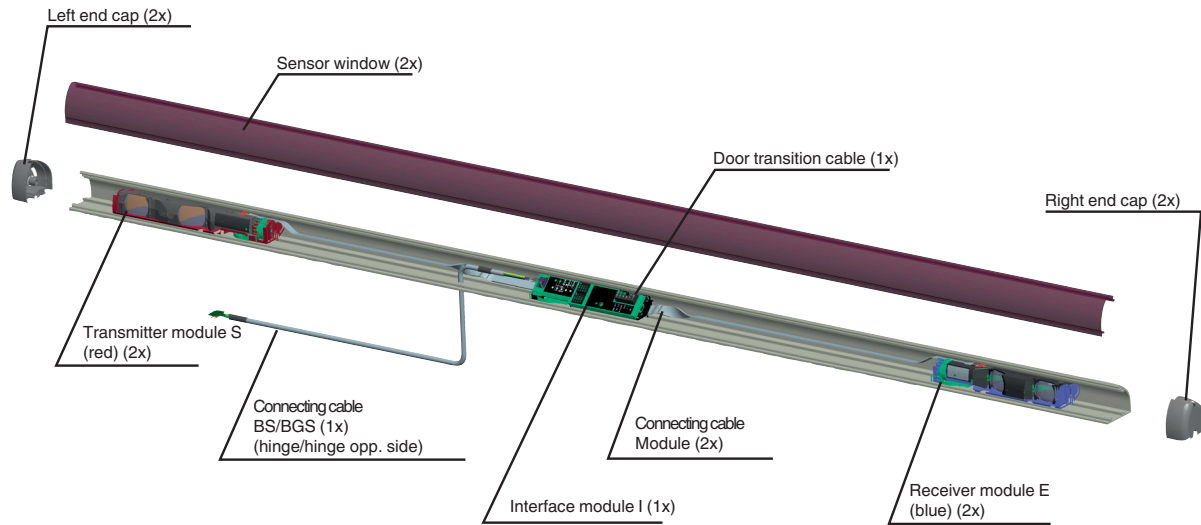

Standby

When the supply voltage is applied, the sensor is put into standby; the energy consumption is reduced to less than 80 % in this state. Once the signal is deactivated, the sensor is immediately ready for operation and enables the signal outputs within 52 ms and/or 200 ms (in boost operating mode) if the detection field is free.

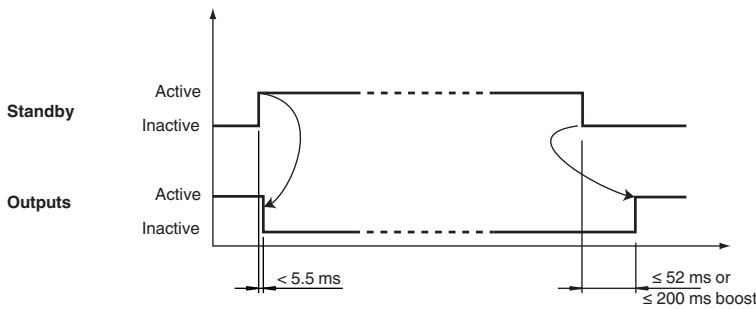

Test input circuit

DoorScan test input circuit

Test Function	Test inactive	Test active	Interface, bottom row, Dip switch 1 and 2
High active	[Circuit diagram: +24V Controller, DoorScan Interface, Test input, GND or open.]	[Circuit diagram: +24V Controller, DoorScan Interface, Test input, GND or open.]	[Dip switch diagram: Switch 1 ON, Switch 2 ON]
Low active	[Circuit diagram: +24V Controller or open, DoorScan Interface, Test input, GND or open.]	[Circuit diagram: +24V Controller or open, DoorScan Interface, Test input, GND or open.]	[Dip switch diagram: Switch 1 ON, Switch 2 OFF]
High inactive	[Circuit diagram: +24V Controller, DoorScan Interface, Test input, GND or open.]	[Circuit diagram: +24V Controller, DoorScan Interface, Test input, GND or open.]	[Dip switch diagram: Switch 1 OFF, Switch 2 ON]
Low inactive	[Circuit diagram: Controller, DoorScan Interface, Test input, GND or open.]	[Circuit diagram: Controller, DoorScan Interface, Test input, GND or open.]	[Dip switch diagram: Switch 1 OFF, Switch 2 OFF]

Test signal

The signal outputs enable crossed circuit detection. To do so, the outputs carry out a delayed shutoff from each other (see signal curve).

Release date: 2020-10-08 Date of issue: 2020-10-08 Filename: 299664_eng.pdf

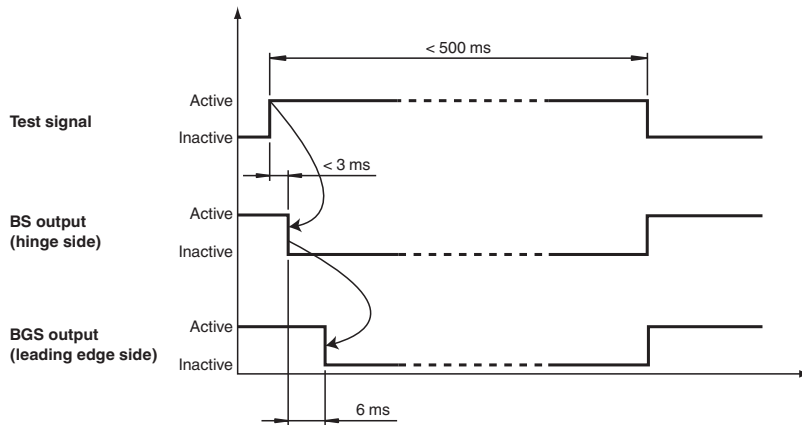
**Note!**

The test signal must be in contact with the test input for at least 9 ms!
The duration of the test signal must not exceed 0.5 s, otherwise this will deactivate the sensor.

Operating modes**Boost operating mode**

Activation with dark floors, even at high installation heights (increased sensitivity). In these cases, the response time of the sensor is increased from 50 ms to 200 ms. If necessary, the speed of the door must be adjusted to the response time.

Grid operating mode

Activation in the event of faults due to metal grating on the ground. Used where metal grating and shafts are present in the detection field.

BEAM

Off: outer beams normal

On: outer beams at an angle (factory setting)

You can switch off the beams extending beyond the emitter modules manually to avoid detection of deep door jambs.

WALL

Off: automatic wall suppression not active

On: automatic wall suppression active (factory setting)

If the door panel does not open against a wall, you can switch off wall suppression to accelerate the commissioning process. Metal grating mode is improved if receiver modules are used from device version V.03 onward.

Accessories

Other suitable accessories can be found at www.pepperl-fuchs.com

Function Principle

DoorScan is an active infrared triangulation sensor with background analysis.

The ground is taught in as a reference and the sensor can learn flat walls on the hinge side and door posts on the leading edge side when the door is opened. This means that person detection can be ensured throughout the entire movement of the door.

Characteristics

The DoorScan housing comprises an aluminum profile system with a plastic cover, which can be adapted to a door width of up to 1200 mm. A minimum of one and a maximum of three emitter and receiver modules must be fitted on each side of the door. The interface must be installed on one side.

The modules should be arranged approx. 10 cm away from the edge of the door. If more than one emitter/receiver module is installed on each side, the modules must be overlapped (S1, S2, E1, E2).

Application

- Protection mechanism for closing edges on automatic doors
- Anti-collision protection for people/objects in the vicinity of revolving or carousel doors.